



Dell Latitude E6440 Owner's Manual

Regulatory Model: P38G
Regulatory Type: P38G001



Notes, Cautions, and Warnings

-  **NOTE:** A NOTE indicates important information that helps you make better use of your computer.
-  **CAUTION:** A CAUTION indicates either potential damage to hardware or loss of data and tells you how to avoid the problem.
-  **WARNING:** A WARNING indicates a potential for property damage, personal injury, or death.

© 2013 Dell Inc. All Rights Reserved.

Trademarks used in this text: Dell™, the Dell logo, Dell Boomi™, Dell Precision™, OptiPlex™, Latitude™, PowerEdge™, PowerVault™, PowerConnect™, OpenManage™, EqualLogic™, Compellent™, KACE™, FlexAddress™, Force10™, Venue™ and Vostro™ are trademarks of Dell Inc. Intel®, Pentium®, Xeon®, Core® and Celeron® are registered trademarks of Intel Corporation in the U.S. and other countries. AMD® is a registered trademark and AMD Opteron™, AMD Phenom™ and AMD Sempron™ are trademarks of Advanced Micro Devices, Inc. Microsoft®, Windows®, Windows Server®, Internet Explorer®, MS-DOS®, Windows Vista® and Active Directory® are either trademarks or registered trademarks of Microsoft Corporation in the United States and/or other countries. Red Hat® and Red Hat® Enterprise Linux® are registered trademarks of Red Hat, Inc. in the United States and/or other countries. Novell® and SUSE® are registered trademarks of Novell Inc. in the United States and other countries. Oracle® is a registered trademark of Oracle Corporation and/or its affiliates. Citrix®, Xen®, XenServer® and XenMotion® are either registered trademarks or trademarks of Citrix Systems, Inc. in the United States and/or other countries. VMware®, vMotion®, vCenter®, vCenter SRM™ and vSphere® are registered trademarks or trademarks of VMware, Inc. in the United States or other countries. IBM® is a registered trademark of International Business Machines Corporation.

2013–10

Rev. A00

Contents

1 Working on Your Computer.....	7
Before Working Inside Your Computer.....	7
Turning Off Your Computer.....	8
After Working Inside Your Computer.....	9
2 Removing and Installing Components.....	11
System Overview.....	11
Removing the Secure Digital (SD) Card.....	12
Installing the Secure Digital (SD) Card.....	12
Removing the ExpressCard.....	13
Installing the ExpressCard.....	13
Removing the Battery.....	13
Installing the Battery.....	13
Removing the Base Cover.....	14
Installing the Base Cover.....	14
Removing the Memory.....	14
Installing the Memory.....	15
Removing the Hard Drive.....	15
Installing the Hard Drive.....	16
Removing the Optical Drive.....	16
Installing the Optical Drive.....	17
Removing the Keyboard Trim.....	17
Installing the Keyboard Trim.....	18
Removing the Keyboard.....	18
Installing the Keyboard.....	20
Removing the WLAN Card.....	20
Installing the WLAN Card.....	21
Removing the WWAN Card.....	21
Installing the WWAN Card.....	22
Removing the Base Corner Caps.....	22
Installing the Base Corner Caps.....	22
Removing the Network Connector.....	23
Installing the Network Connector.....	23
Removing the Coin-Cell Battery.....	24
Installing the Coin-Cell Battery.....	24
Removing the Heatsink Assembly.....	24
Installing the Heatsink Assembly.....	25
Removing the Processor.....	26

Installing the Processor.....	26
Removing the Power Connector.....	26
Installing the Power Connector.....	28
Removing the Display-Hinge Cover.....	28
Installing the Display-Hinge Cover.....	28
Removing the Palmrest Assembly.....	29
Installing the Palmrest Assembly.....	30
Removing the ExpressCard Cage.....	31
Installing the ExpressCard Cage.....	32
Removing the WiFi-Switch Board.....	33
Installing the WiFi-Switch Board.....	34
Removing the System Board.....	34
Installing the System Board.....	36
Removing the Speakers.....	37
Installing the Speakers.....	37
Removing the I/O Board.....	38
Installing the I/O Board.....	39
Removing the Display Assembly.....	40
Installing the Display Assembly.....	41
Removing the Display Bezel.....	42
Installing the Display Bezel.....	43
Removing the Display Panel.....	44
Installing the Display Panel.....	46
Removing the Display Hinges.....	47
Installing the Display Hinges.....	47
Removing the Camera.....	48
Installing the Camera.....	48
3 System Setup.....	49
Boot Sequence.....	49
Navigation Keys.....	49
System Setup Options.....	50
Updating the BIOS	59
System and Setup Password.....	59
Assigning a System Password and Setup Password.....	59
Deleting or Changing an Existing System and/or Setup Password.....	60
4 Diagnostics.....	61
Enhanced Pre-Boot System Assessment (ePSA) Diagnostics.....	61
Device Status Lights.....	61
Battery Status Lights.....	62

5 Technical Specifications.....	63
6 Contacting Dell.....	69

Working on Your Computer

Before Working Inside Your Computer

Use the following safety guidelines to help protect your computer from potential damage and to help to ensure your personal safety. Unless otherwise noted, each procedure included in this document assumes that the following conditions exist:

- You have performed the steps in Working on Your Computer.
- You have read the safety information that shipped with your computer.
- A component can be replaced or--if purchased separately--installed by performing the removal procedure in reverse order.

 **WARNING:** Before working inside your computer, read the safety information that shipped with your computer. For additional safety best practices information, see the Regulatory Compliance Homepage at www.dell.com/regulatory_compliance

 **CAUTION:** Many repairs may only be done by a certified service technician. You should only perform troubleshooting and simple repairs as authorized in your product documentation, or as directed by the online or telephone service and support team. Damage due to servicing that is not authorized by Dell is not covered by your warranty. Read and follow the safety instructions that came with the product.

 **CAUTION:** To avoid electrostatic discharge, ground yourself by using a wrist grounding strap or by periodically touching an unpainted metal surface, such as a connector on the back of the computer.

 **CAUTION:** Handle components and cards with care. Do not touch the components or contacts on a card. Hold a card by its edges or by its metal mounting bracket. Hold a component such as a processor by its edges, not by its pins.

 **CAUTION:** When you disconnect a cable, pull on its connector or on its pull-tab, not on the cable itself. Some cables have connectors with locking tabs; if you are disconnecting this type of cable, press in on the locking tabs before you disconnect the cable. As you pull connectors apart, keep them evenly aligned to avoid bending any connector pins. Also, before you connect a cable, ensure that both connectors are correctly oriented and aligned.

 **NOTE:** The color of your computer and certain components may appear differently than shown in this document.

To avoid damaging your computer, perform the following steps before you begin working inside the computer.

1. Ensure that your work surface is flat and clean to prevent the computer cover from being scratched.
2. Turn off your computer (see [Turning Off Your Computer](#)).
3. If the computer is connected to a docking device (docked) such as the optional Media Base or Battery Slice, undock it.

 **CAUTION:** To disconnect a network cable, first unplug the cable from your computer and then unplug the cable from the network device.

4. Disconnect all network cables from the computer.
5. Disconnect your computer and all attached devices from their electrical outlets.

6. Close the display and turn the computer upside-down on a flat work surface.



NOTE: To avoid damaging the system board, you must remove the main battery before you service the computer.

7. Remove the main battery.
8. Turn the computer top-side up.
9. Open the display.
10. Press the power button to ground the system board.



CAUTION: To guard against electrical shock, always unplug your computer from the electrical outlet before opening the display.



CAUTION: Before touching anything inside your computer, ground yourself by touching an unpainted metal surface, such as the metal at the back of the computer. While you work, periodically touch an unpainted metal surface to dissipate static electricity, which could harm internal components.

11. Remove any installed ExpressCards or Smart Cards from the appropriate slots.

Turning Off Your Computer



CAUTION: To avoid losing data, save and close all open files and exit all open programs before you turn off your computer.

1. Shut down the operating system:

- In Windows 8:

- Using a touch-enabled device:

- a. Swipe in from the right edge of the screen, opening the Charms menu and select **Settings**.
- b. Select the  and then select **Shut down**

- Using a mouse:

- a. Point to upper-right corner of the screen and click **Settings**.
- b. Click the  and select **Shut down**.

- In Windows 7:

1. Click **Start** .
2. Click **Shut Down**.

or

1. Click **Start** .
2. Click the arrow in the lower-right corner of the **Start** menu as shown below, and then click **Shut Down**.



2. Ensure that the computer and all attached devices are turned off. If your computer and attached devices did not automatically turn off when you shut down your operating system, press and hold the power button for about 4 seconds to turn them off.

After Working Inside Your Computer

After you complete any replacement procedure, ensure you connect any external devices, cards, and cables before turning on your computer.



CAUTION: To avoid damage to the computer, use only the battery designed for this particular Dell computer. Do not use batteries designed for other Dell computers.

1. Connect any external devices, such as a port replicator, battery slice, or media base, and replace any cards, such as an ExpressCard.
2. Connect any telephone or network cables to your computer.



CAUTION: To connect a network cable, first plug the cable into the network device and then plug it into the computer.

3. Replace the battery.
4. Connect your computer and all attached devices to their electrical outlets.
5. Turn on your computer.

Removing and Installing Components

This section provides detailed information on how to remove or install the components from your computer.

System Overview

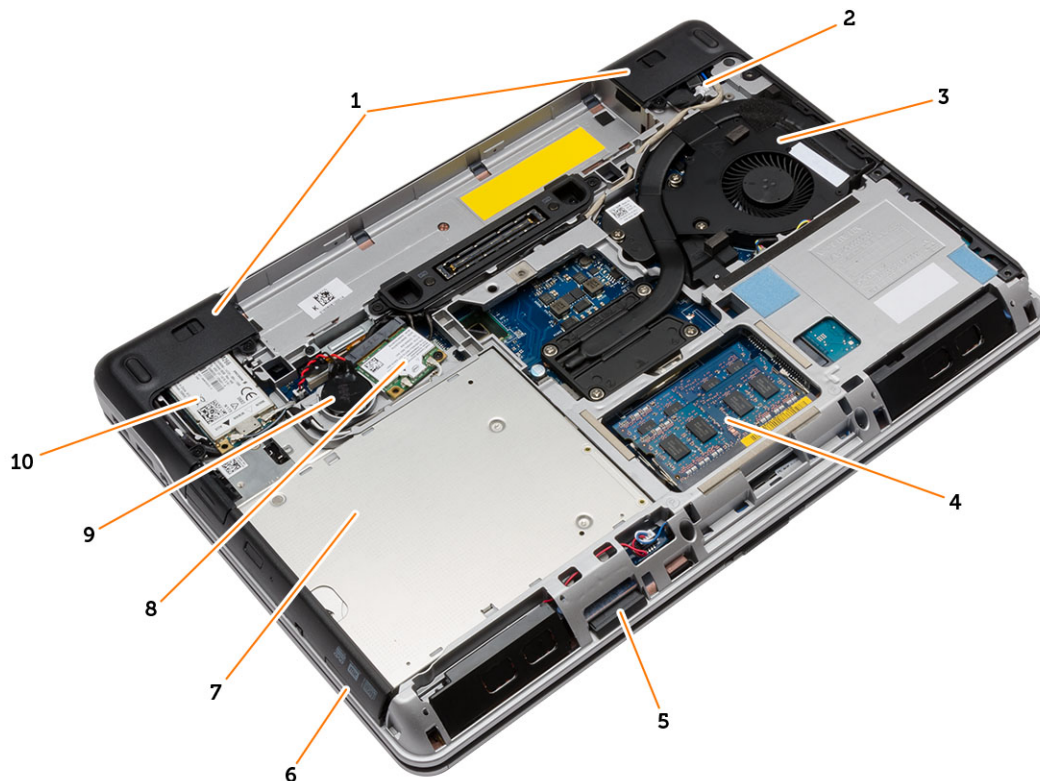

Figure 1. Back View — Back Cover Removed

- | | |
|----------------------|---------------------|
| 1. base corner caps | 2. power connector |
| 3. heatsink assembly | 4. memory module |
| 5. SD card | 6. ExpressCard slot |
| 7. optical drive | 8. WLAN card |
| 9. coin-cell battery | 10. WWAN card |

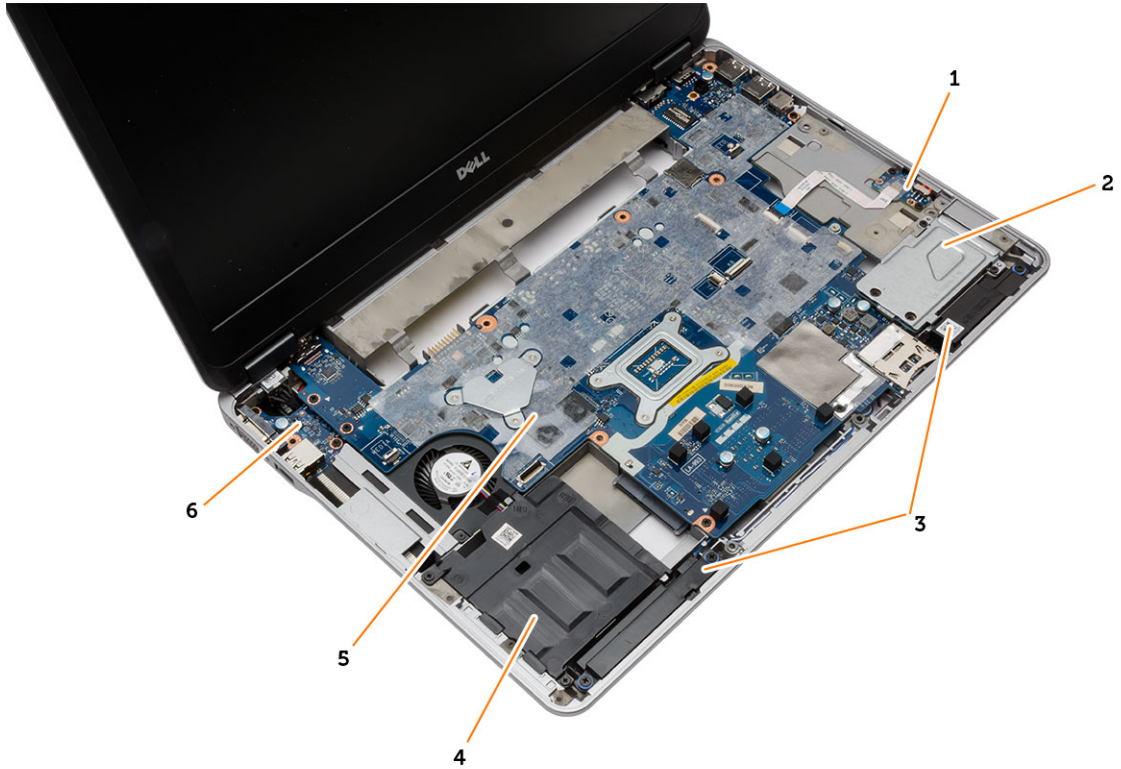

Figure 2. Top View — Keyboard and Palmrest Assembly removed

- | | |
|----------------------|---------------------|
| 1. WiFi-switch board | 2. ExpressCard cage |
| 3. speakers | 4. hard-drive bay |
| 5. system board | 6. I/O board |

Removing the Secure Digital (SD) Card

1. Follow the procedures in *Before Working Inside Your Computer*.
2. Press in on the SD card to release it from the computer. Slide the SD card out of the computer.



Installing the Secure Digital (SD) Card

1. Slide the SD card into its slot until it clicks into place.
2. Follow the procedures in *After Working Inside Your Computer*.

Removing the ExpressCard

1. Follow the procedures in *Before Working Inside Your Computer*.
2. Press in on the ExpressCard to release it from the computer. Slide the ExpressCard out of the computer.

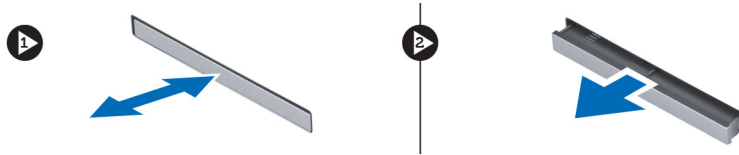

Installing the ExpressCard

1. Slide the ExpressCard in its slot until it clicks in place.
2. Follow the procedures in *After Working Inside Your Computer*.

Removing the Battery

1. Follow the procedures in *Before Working Inside Your Computer*.
2. Slide the release latches and flip the battery out of the computer.



Installing the Battery

1. Slide the battery into its slot until it clicks into place.
2. Follow the procedures in *After Working Inside Your Computer*.

Removing the Base Cover

1. Follow the procedures in *Before Working Inside Your Computer*.
2. Remove the screws that secure the base cover to the computer. Lift the base cover and remove it from the computer.

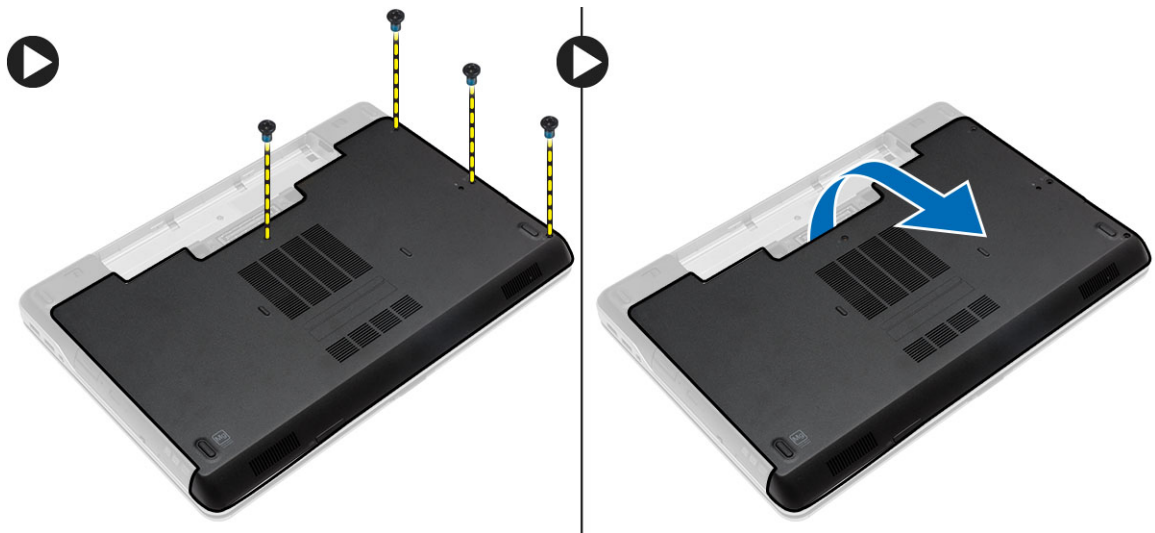

Installing the Base Cover

1. Place the base cover to align with the screw holes on the computer.
2. Tighten the screws to secure the base cover to the computer.
3. Install the battery.
4. Follow the procedures in *After Working Inside Your Computer*.

Removing the Memory

1. Follow the procedures in *Before Working Inside Your Computer*.
2. Remove:
 - a. battery
 - b. base cover
3. Pry the securing clips away from the memory module until it pops-up and remove the memory module from its connector on the system board.

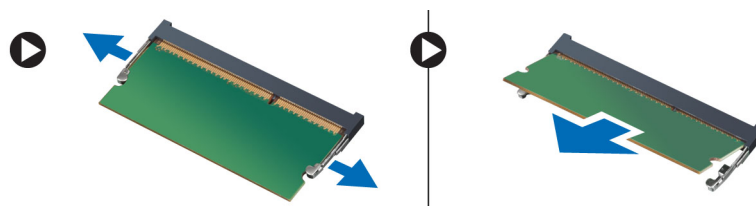

Installing the Memory

1. Insert the memory into the memory socket.
2. Press the securing clips to secure the memory module to the system board.
3. Install:
 - a. base cover
 - b. battery
4. Follow the procedures in *After Working Inside Your Computer*.

Removing the Hard Drive

1. Follow the procedures in *Before Working Inside Your Computer*.
2. Remove the battery.
3. Remove the screws that secure the hard drive to the computer. Slide the hard drive out of the computer.



4. Remove the screw that secures the hard-drive caddy to the hard drive. Remove the hard-drive caddy from the hard drive.



5. Flex the hard-drive isolation. Peel off the hard-drive isolation from the hard drive.



Installing the Hard Drive

1. Fix the hard-drive isolation on the hard drive.
2. Attach the hard-drive caddy to the hard drive.
3. Tighten the screws to secure the hard-drive caddy to the hard drive.
4. Slide the hard drive into the computer.
5. Tighten the screws to secure the hard drive to the computer.
6. Install the battery.
7. Follow the procedures in *After Working Inside Your Computer*.

Removing the Optical Drive

1. Follow the procedures in *Before Working Inside Your Computer*.
2. Remove the battery.
3. Perform the steps as shown in the illustration:
 - a. Press the optical-drive latch.
 - b. Release the optical drive.
 - c. Pull the optical drive from the computer.

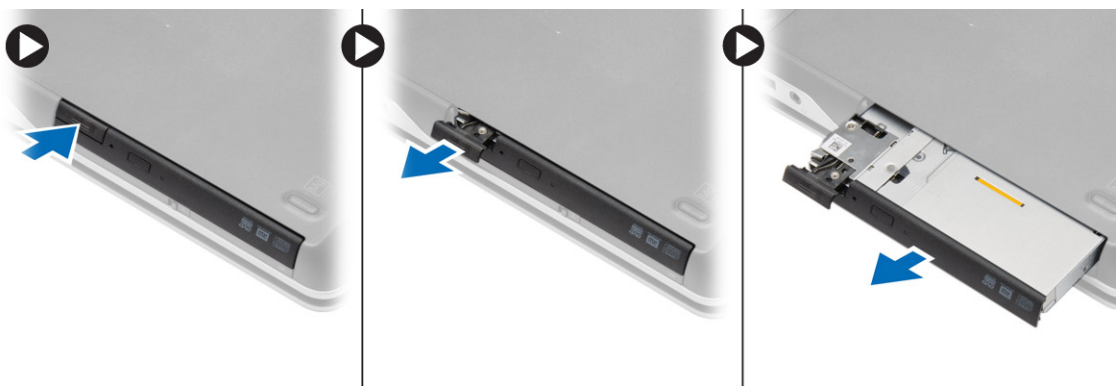

4. Remove the screw that secures the optical-drive latch to the optical drive. Slide the optical-drive latch and remove it from the optical-drive.

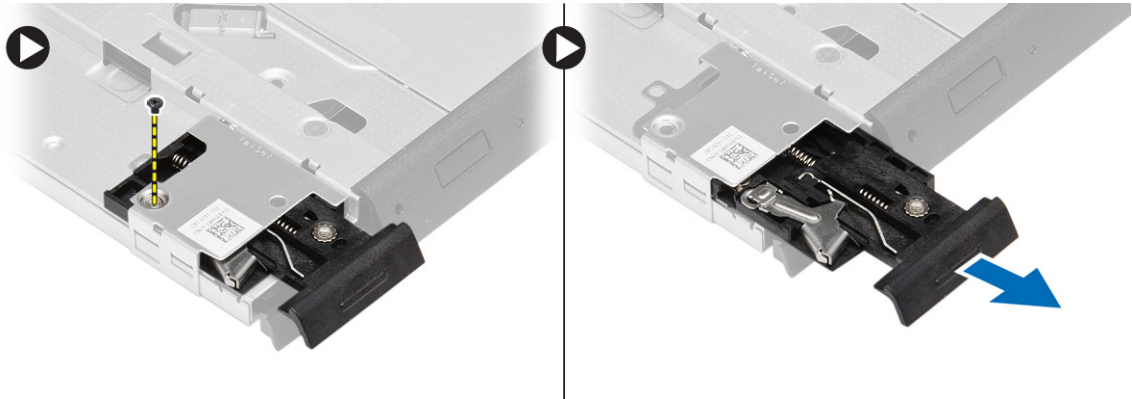

5. Remove the screws that secure the optical-drive latch bracket to the optical drive. Remove the latch bracket from the optical drive.

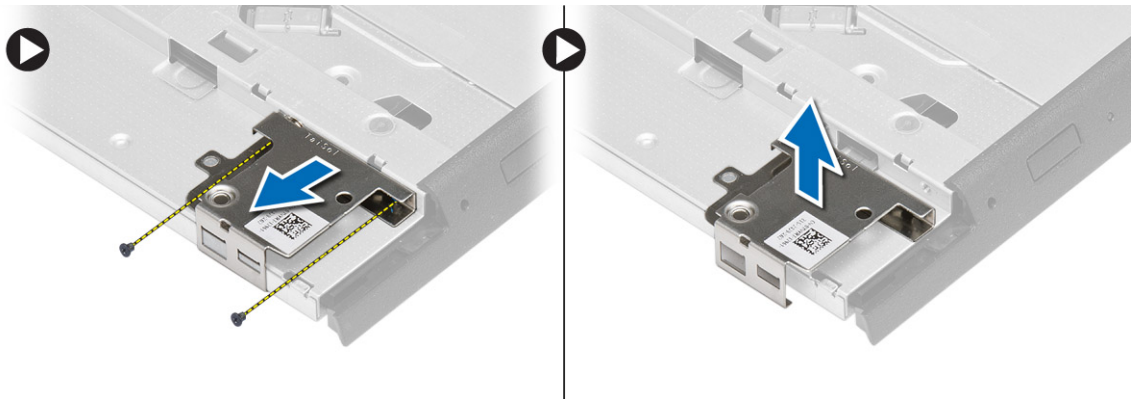

Installing the Optical Drive

1. Align the optical-drive latch bracket to its position on the optical drive.
2. Tighten the screw to secure the optical-drive latch bracket to the optical drive.
3. Slide the optical-drive latch in the optical-drive latch bracket.
4. Tighten the screws to secure the optical-drive latch to the optical-drive latch bracket.
5. Slide the optical drive into the drive bay.
6. Press the optical-drive latch to secure the optical drive.
7. Install the battery.
8. Follow the procedures in *After Working Inside Your Computer*.

Removing the Keyboard Trim

1. Follow the procedures in *Before Working Inside Your Computer*.
2. Remove battery.

3. Using a plastic scribe, pry the keyboard trim to release it from the computer. Lift it up to remove the keyboard trim from the computer.

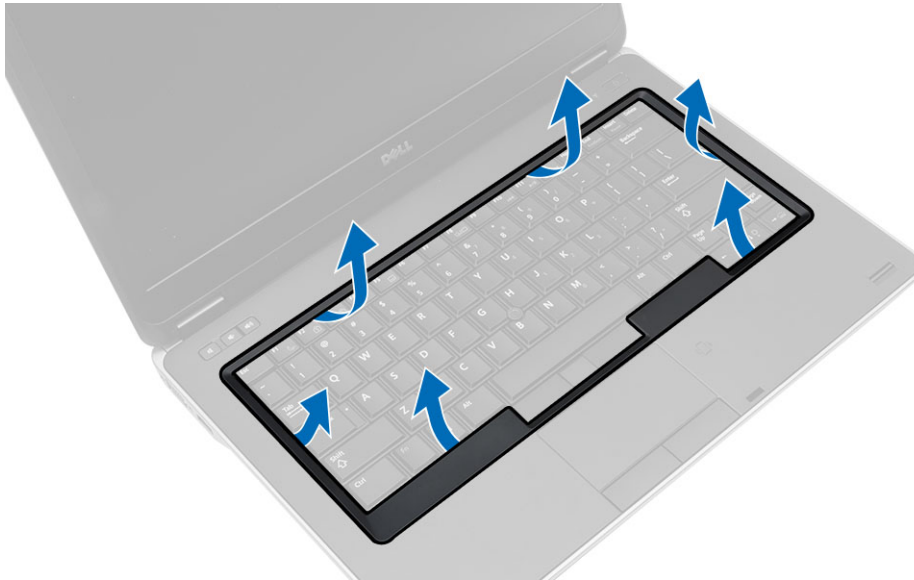

Installing the Keyboard Trim

1. Align the keyboard trim to its slot.
2. Press along the sides of the keyboard trim until it clicks in place.
3. Install battery.
4. Follow the procedures in *After Working Inside Your Computer*.

Removing the Keyboard

1. Follow the procedures in *Before Working Inside Your Computer*.
2. Remove the:
 - a. battery
 - b. keyboard trim

3. Remove the screws on the back of the computer and flip the computer.



4. Remove the screws that secure the keyboard to the palmrest assembly, lift and flip the keyboard to access the keyboard-cable.

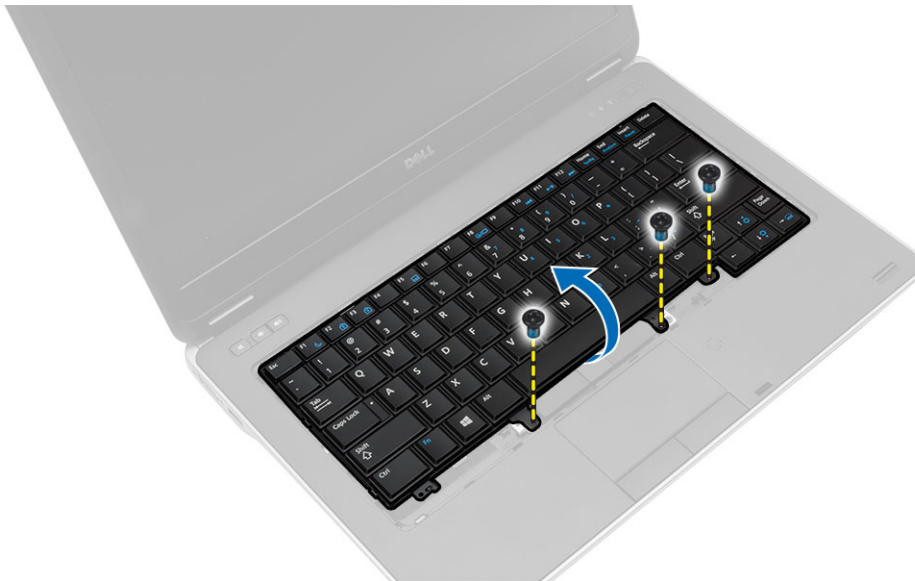

5. Disconnect the keyboard cable from the system board.

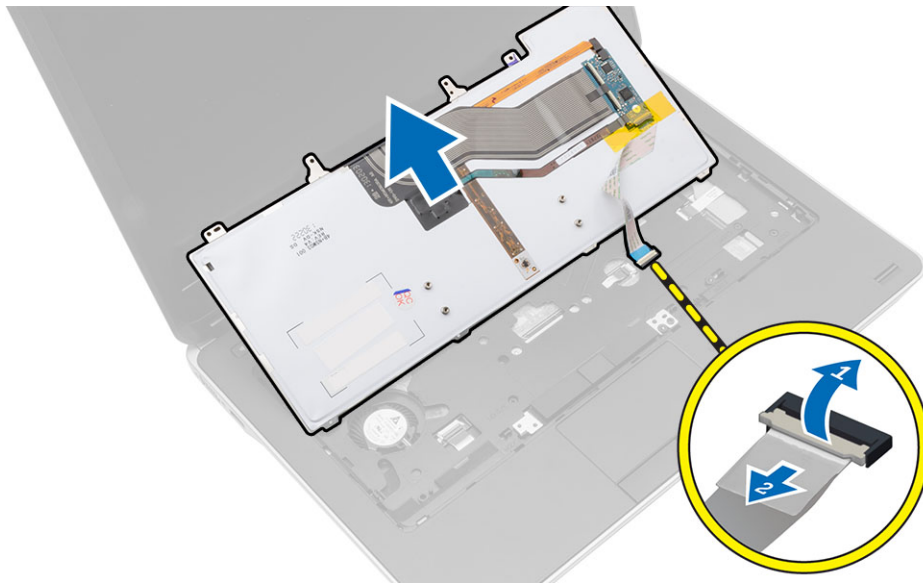

Installing the Keyboard

1. Connect the keyboard cable to the system board.
2. Slide the keyboard into its compartment until it clicks into place.
3. Tighten the screws to secure the keyboard to the palmrest assembly.
4. Flip the computer and tighten the screws on the back of the computer.
5. Install the keyboard trim.
6. Install the battery.
7. Follow the procedures in *After Working Inside Your Computer*.

Removing the WLAN Card

1. Follow the procedures in *Before Working Inside Your Computer*.
2. Remove:
 - a. battery
 - b. base cover

3. Perform the following steps:
 - a. Disconnect the antenna cables from the WLAN card.
 - b. Remove the screw that secures the WLAN card to the system board.
 - c. Remove the WLAN card from the computer.



Installing the WLAN Card

1. Insert the WLAN card in its connector at a 45-degree angle in its slot.
2. Connect the antenna cables to their respective connectors marked on the WLAN card.
3. Tighten the screw to secure the WLAN card to the computer.
4. Install:
 - a. base cover
 - b. battery
5. Follow the procedures in *After Working Inside Your Computer*.

Removing the WWAN Card

1. Follow the procedures in *Before Working Inside Your Computer*.
2. Remove:
 - a. battery
 - b. base cover
3. Perform the following steps as shown in the illustration:
 - a. Disconnect the antenna cables from the WWAN card.
 - b. Remove the screw that secures the WWAN card to the computer.
 - c. Remove the WWAN card from the computer.

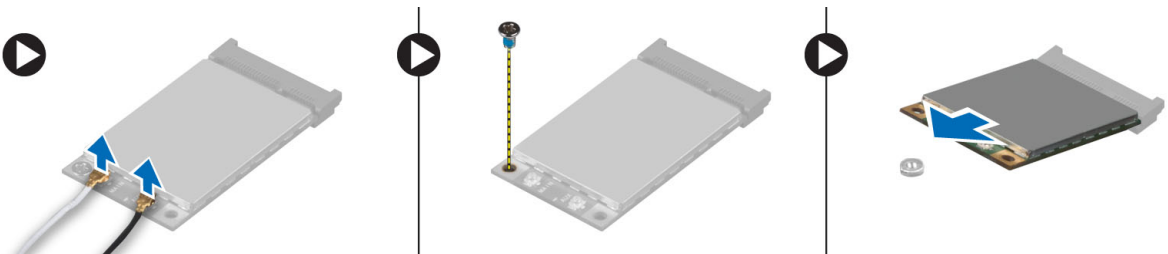

Installing the WWAN Card

1. Place the WWAN card in its slot in the system board.
2. Press the WWAN card down and tighten the screw to secure the WWAN card to the computer.
3. Connect the antenna cables to their connectors on the WWAN card.
4. Install:
 - a. base cover
 - b. battery
5. Follow the procedures in *After Working Inside Your Computer*.

Removing the Base Corner Caps

1. Follow the procedures in *Before Working Inside Your Computer*.
2. Remove the:
 - a. battery
 - b. base cover
 - c. hard drive
3. Remove the screws that secure the left base corner cap, lift and remove it from the computer.



4. Remove the screw that secures the right base corner cap, lift and remove it from the computer.

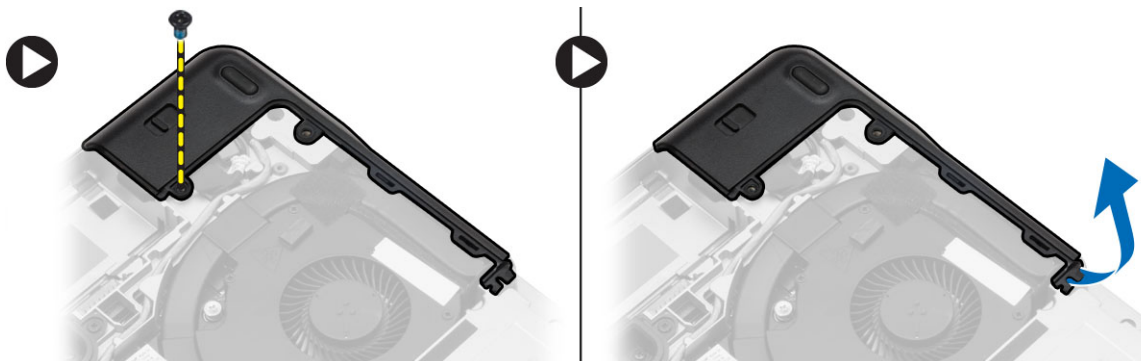

Installing the Base Corner Caps

1. Place the left and right base corner caps to align with the screw holes on the computer.
2. Tighten the screws to secure the base corner caps to the computer.

3. Install:
 - a. base cover
 - b. battery
4. Follow the procedures in *After Working Inside Your Computer*.

Removing the Network Connector

1. Follow the procedures in *Before Working Inside Your Computer*.
2. Remove:
 - a. battery
 - b. base cover
 - c. base corner cap (left)
3. Perform the following steps as shown in the illustration:
 - a. Disconnect the cable from the system board [1].
 - b. Release cable from the routing channel [2].
 - c. Remove the screw that secures the network-connector bracket to the computer.

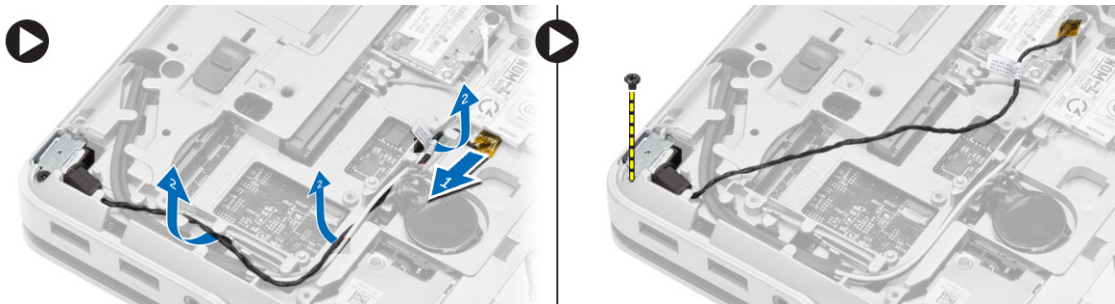

4. Remove the network-connector bracket from the computer. Lift the network connector from the computer.

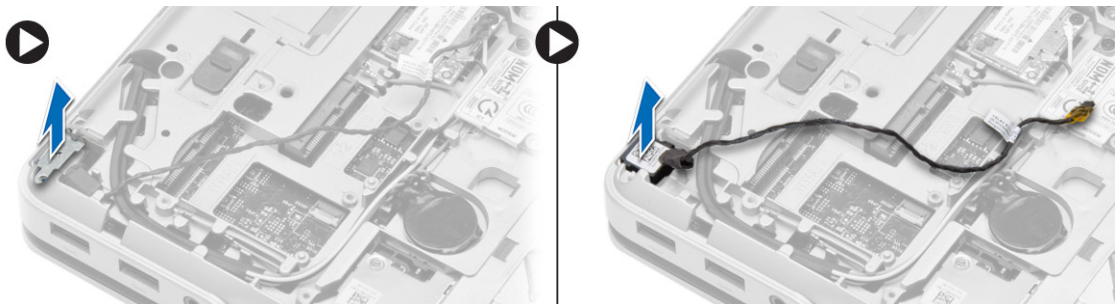

Installing the Network Connector

1. Align the network connector to its position on the computer.
2. Place the network-connector bracket on the network connector.
3. Tighten the screw to secure the network-connector bracket to the computer.
4. Route the cable through the routing channel.
5. Connect the cable to the system board.

6. Install:
 - a. base corner cap (left)
 - b. base cover
 - c. battery
7. Follow the procedures in *After Working Inside Your Computer*.

Removing the Coin-Cell Battery

1. Follow the procedures in *Before Working Inside Your Computer*.
2. Remove:
 - a. battery
 - b. base cover
3. Disconnect the coin-cell battery cable, pry the coin-cell battery upward and remove it from the computer.

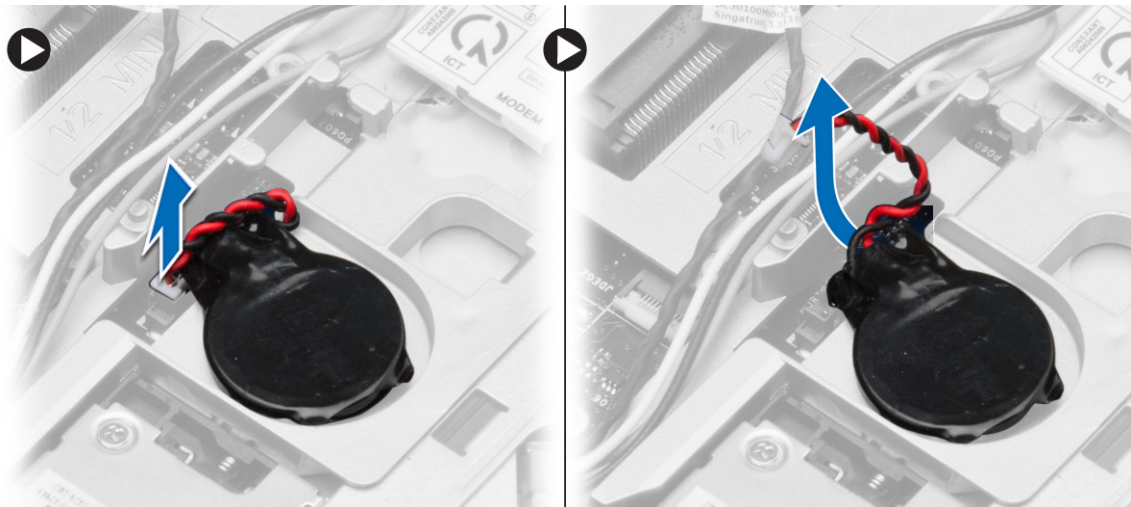

Installing the Coin-Cell Battery

1. Place the coin-cell battery in its slot.
2. Connect the coin-cell battery cable to the system board.
3. Install:
 - a. base cover
 - b. battery
4. Follow the procedures in *After Working Inside Your Computer*.

Removing the Heatsink Assembly

1. Follow the procedures in *Before Working Inside Your Computer*.
2. Remove:
 - a. battery
 - b. base cover

3. Disconnect the fan cable and remove the screws that secure the heatsink assembly to the system board.

 **NOTE:** Remove the screws in the numerical order as displayed in the image.

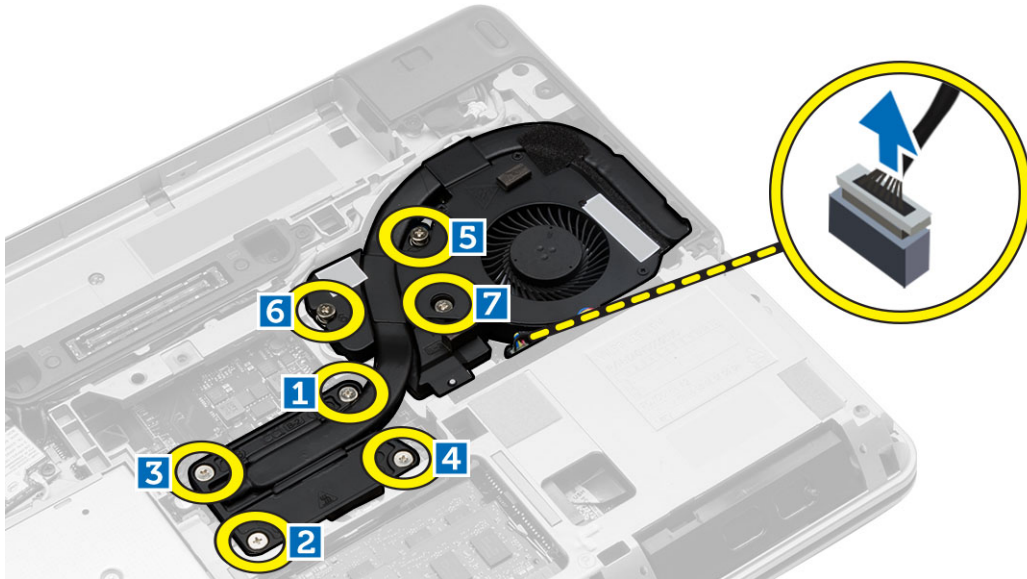

4. Perform the following steps as shown in the illustration:
 - a. Lift the heatsink assembly from the computer.
 - b. Slide the heatsink assembly.

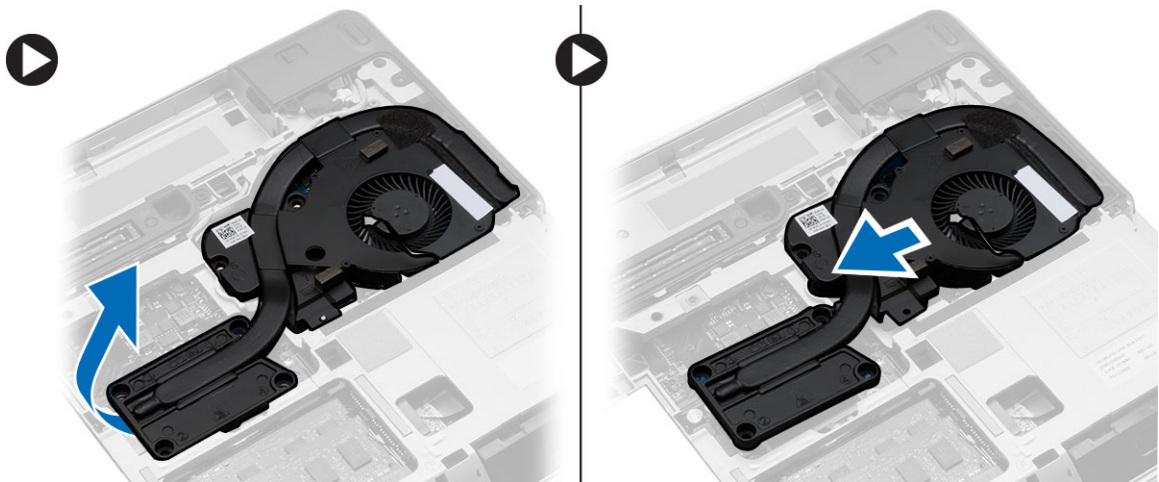

Installing the Heatsink Assembly

1. Place the heatsink assembly to its position on the system board.
2. Tighten the screws to secure the heatsink assembly to the system board.
3. Connect the fan cable to the system board.
4. Install:
 - a. base cover
 - b. battery

5. Follow the procedures in *After Working Inside Your Computer*.

Removing the Processor

1. Follow the procedures in *Before Working Inside Your Computer*.
2. Remove:
 - a. battery
 - b. base cover
 - c. heatsink assembly
3. Rotate the processor-cam lock in a counter-clockwise direction. Remove the processor from the computer.

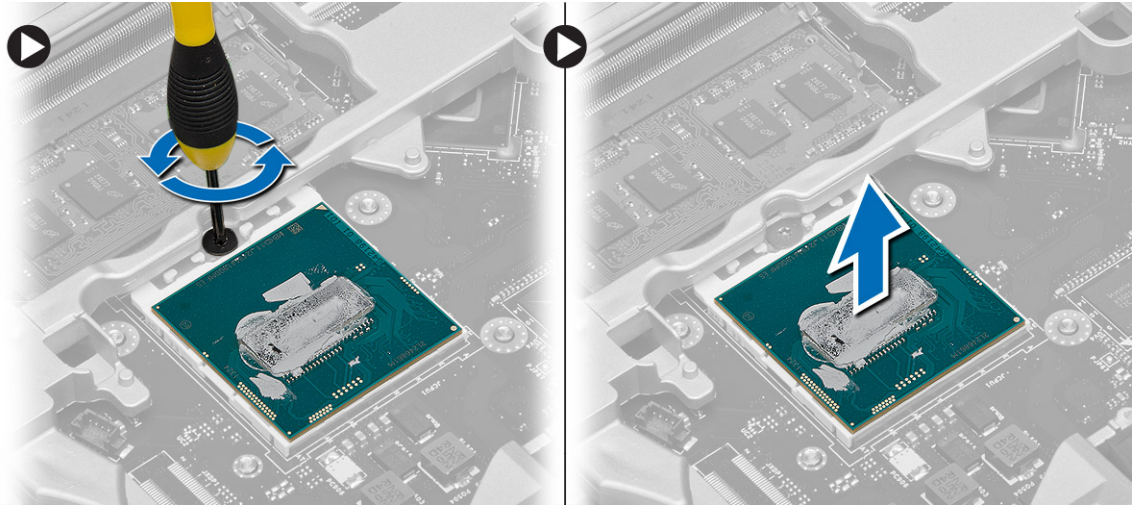

Installing the Processor

1. Align the notches on the processor and the socket, and insert the processor into the socket.
2. Rotate the processor-cam lock in a clockwise direction.
3. Install:
 - a. heatsink assembly
 - b. base cover
 - c. battery
4. Follow the procedures in *After Working Inside Your Computer*.

Removing the Power Connector

1. Follow the procedures in *Before Working Inside Your Computer*.
2. Remove:
 - a. battery
 - b. base corner cap (right)
 - c. base cover

3. Remove the screw that secures the bracket to the computer and disconnect the camera cable that secures the power connector to the computer.

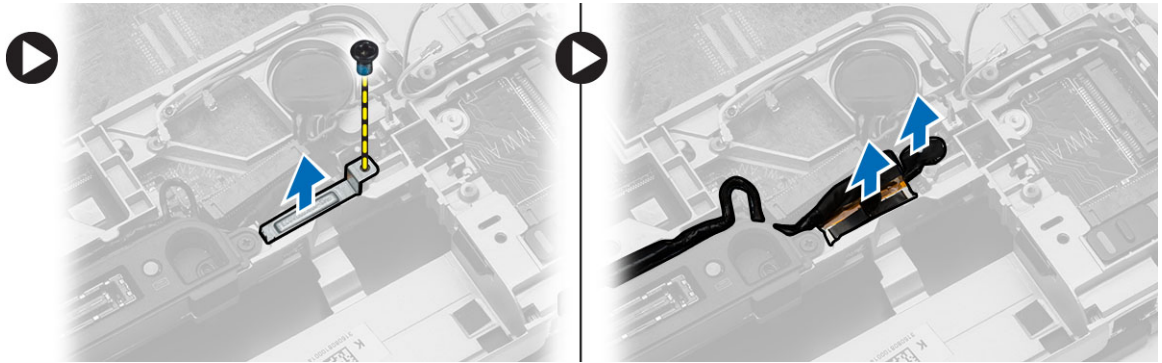

4. Unroute the camera and the LVDS cables that secure the power connector to the computer.

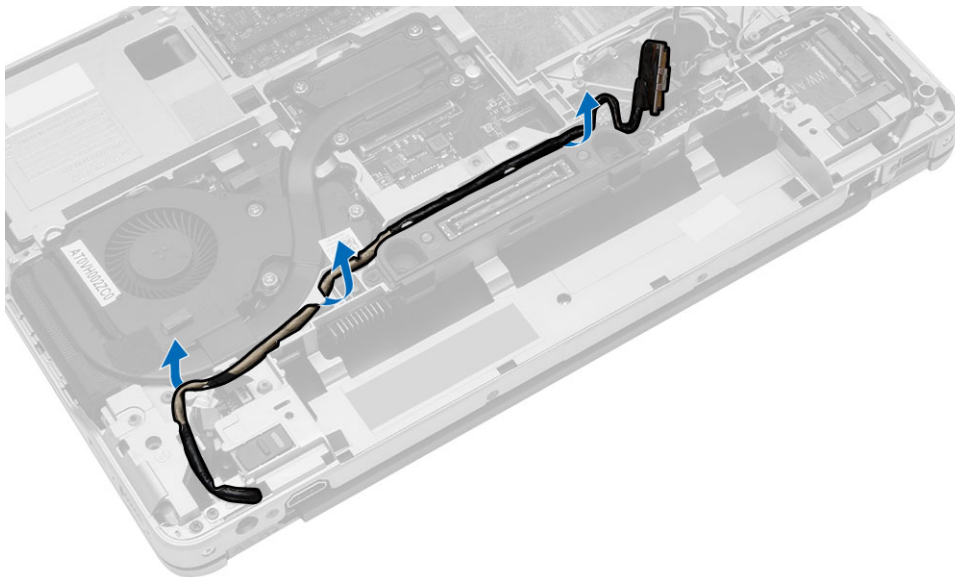

5. Disconnect the power-connector cable and remove the screw that secures the power connector to the computer.

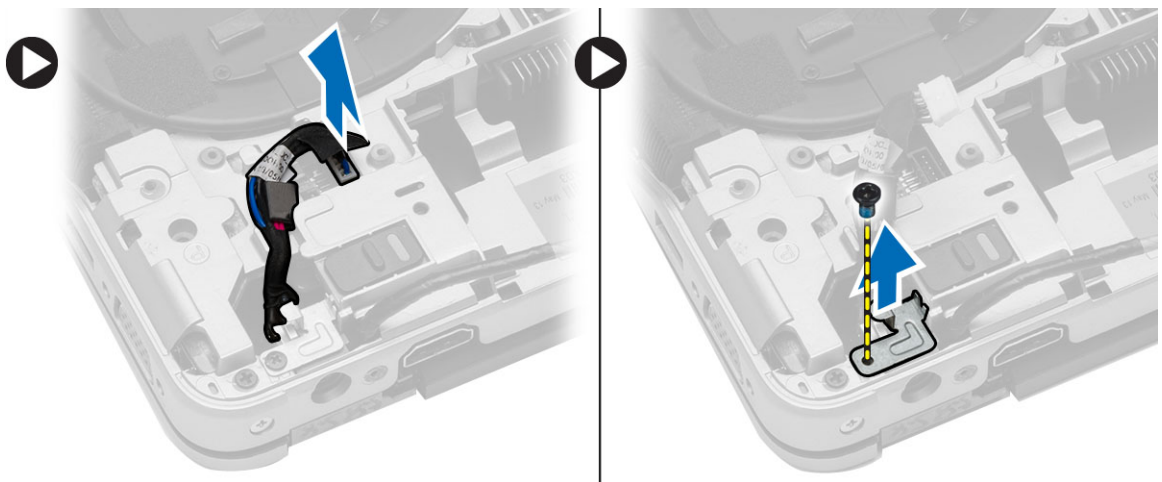

Installing the Power Connector

1. Place the power connector in its slot.
2. Connect the power-connector cable and tighten the screw that secures the power connector to the computer.
3. Route the camera cable and the LVDS cable that secures the power connector to the computer.
4. Tighten the screw to secure the power-connector bracket to the computer and connect the camera cable that secures the power connector to the computer.
5. Install:
 - a. base cover
 - b. base corner cap (right)
 - c. battery
6. Follow the procedures in *After Working Inside Your Computer*.

Removing the Display-Hinge Cover

1. Follow the procedures in *Before Working Inside Your Computer*.
2. Remove the battery.
3. Remove the screws that secure the display-hinge cover to the computer and remove it from the computer.

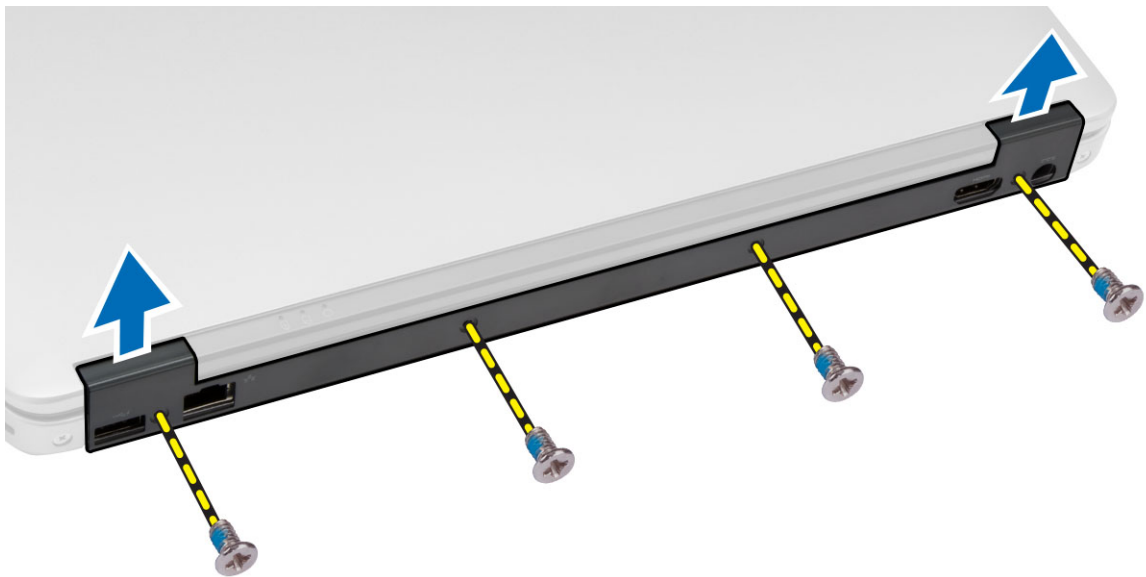

Installing the Display-Hinge Cover

1. Align the display-hinge cover with the screw holes.
2. Tighten the screws to secure the display-hinge cover to the computer.
3. Install the battery.
4. Follow the procedures in *After Working Inside Your Computer*.

Removing the Palmrest Assembly

1. Follow the procedures in *Before Working Inside Your Computer*.
2. Remove:
 - a. SD card
 - b. ExpressCard
 - c. battery
 - d. keyboard trim
 - e. keyboard
 - f. hard drive
 - g. optical drive
 - h. display-hinge cover
 - i. base cover
 - j. base corner caps
3. Remove the screws that secure the palmrest assembly to the base of the computer.

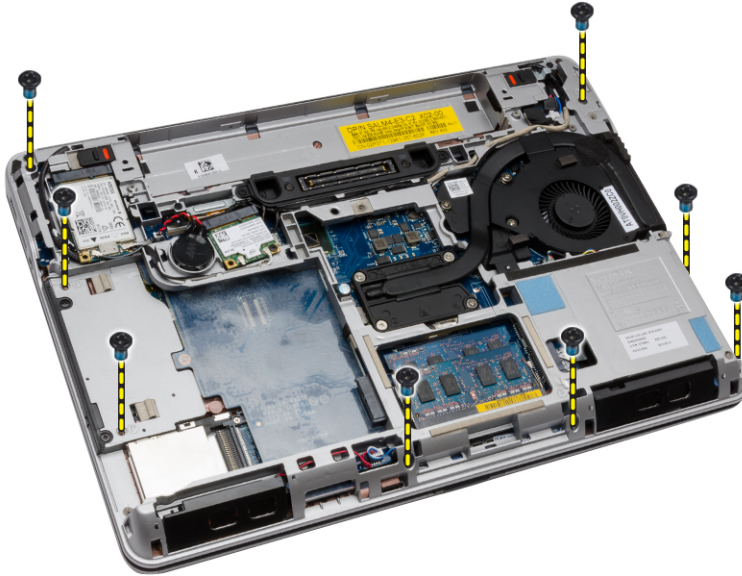

4. Flip the computer and disconnect the following cables:
 - a. media board
 - b. Unified Security Hub (USH) board
 - c. touchpad
 - d. Wi-Fi board
 - e. LED board

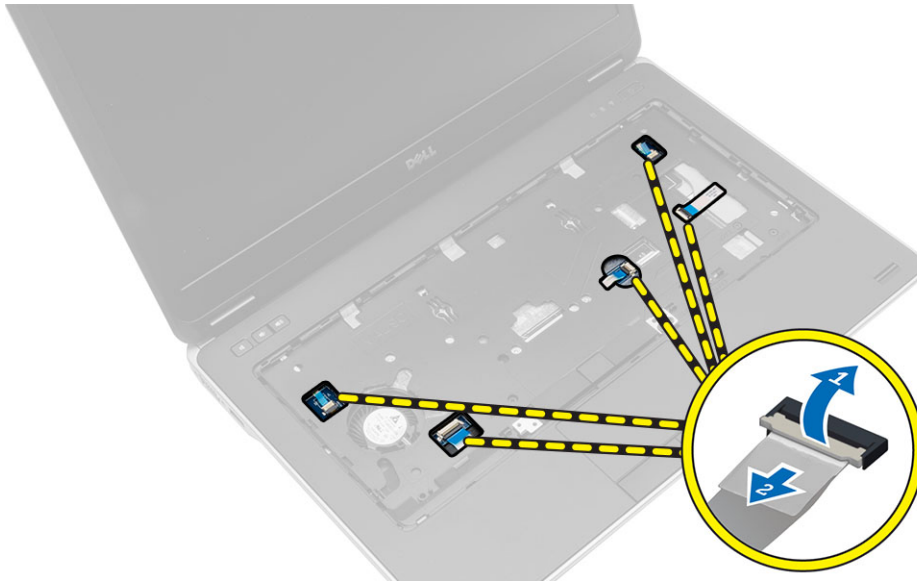

5. Remove the screws that secure the palmrest assembly to the computer.



Installing the Palmrest Assembly

1. Align the palmrest assembly to its original position in the computer and snap it into place.
2. Tighten the screws to secure the palmrest assembly to the computer.

3. Connect the following cables:
 - a. media board
 - b. Unified Security Hub (USH) board
 - c. touchpad
 - d. Wi-Fi board
 - e. LED board
4. Flip the computer and tighten the screws to secure the palmrest assembly to the base of the computer.
5. Install:
 - a. base corner caps
 - b. base cover
 - c. display-hinge cover
 - d. optical drive
 - e. hard drive
 - f. keyboard
 - g. keyboard trim
 - h. battery
 - i. ExpressCard
 - j. SD card
6. Follow the procedures in *After Working Inside Your Computer*.

Removing the ExpressCard Cage

1. Follow the procedures in *Before Working Inside Your Computer*.
2. Remove:
 - a. SD Card
 - b. ExpressCard
 - c. battery
 - d. keyboard trim
 - e. keyboard
 - f. hard drive
 - g. optical drive
 - h. display-hinge cover
 - i. base cover
 - j. base corner caps
 - k. palmrest assembly

3. Remove the screws that secure the ExpressCard cage cover to the computer. Remove the ExpressCard cage cover from the computer.

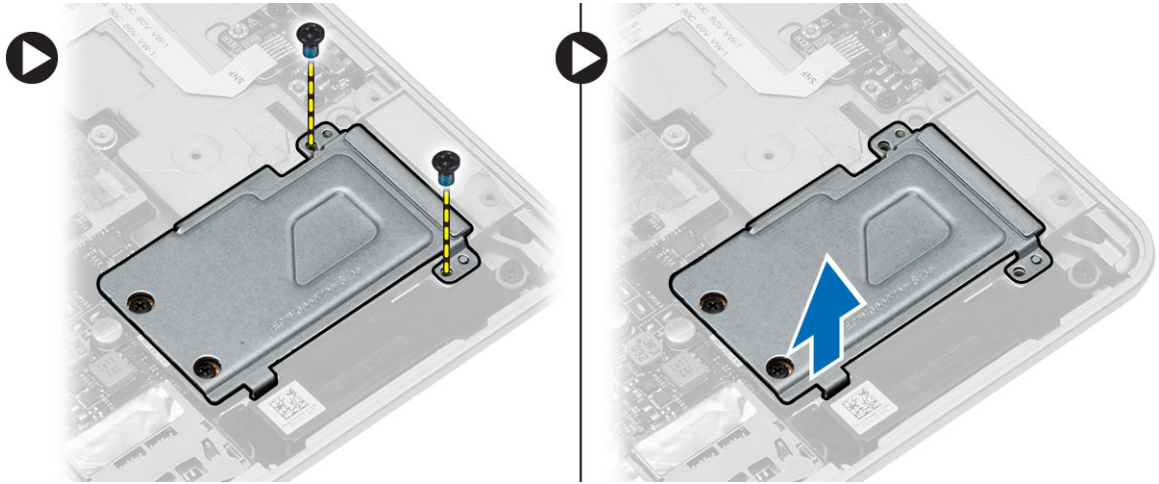

4. Remove the screws that secure the ExpressCard cage to the system board. Remove the ExpressCard cage from the system board.

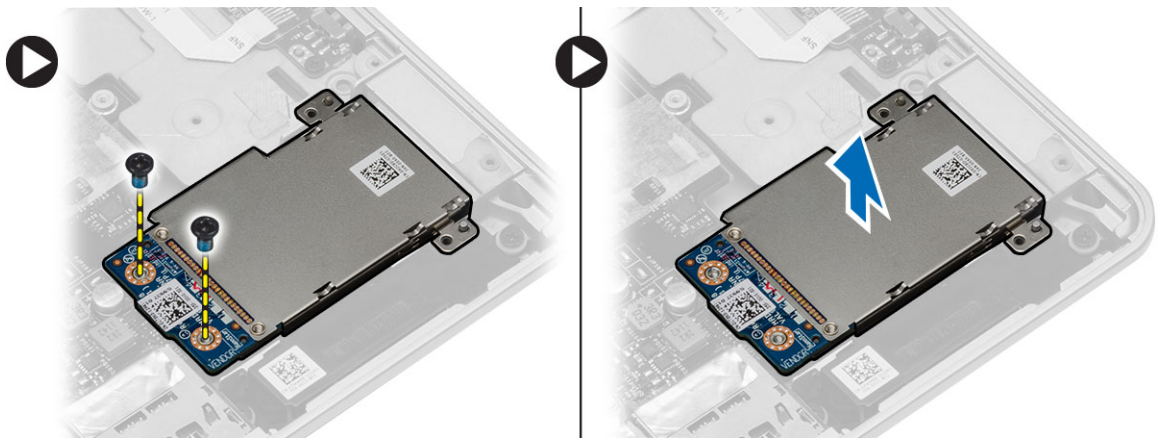

Installing the ExpressCard Cage

1. Place the ExpressCard cage in its slot.
2. Tighten the screws to secure the ExpressCard cage to the system board.
3. Tighten the screw to secure the ExpressCard cage cover to the computer.

4. Install:
 - a. palmrest assembly
 - b. base corner caps
 - c. base cover
 - d. display-hinge cover
 - e. optical drive
 - f. hard drive
 - g. keyboard
 - h. keyboard trim
 - i. battery
 - j. ExpressCard
 - k. SD Card
5. Follow the procedures in *After Working Inside Your Computer*.

Removing the WiFi-Switch Board

1. Follow the procedures in *Before Working Inside Your Computer*.
2. Remove:
 - a. SD Card
 - b. ExpressCard
 - c. battery
 - d. keyboard trim
 - e. keyboard
 - f. hard drive
 - g. optical drive
 - h. display-hinge cover
 - i. base cover
 - j. base corner caps
 - k. palmrest assembly
3. Perform the following steps as shown in the illustration:
 - a. Disconnect the WiFi-switch board cable from the system board.
 - b. Remove the screws that secure the WiFi-switch board and lift it from the computer.

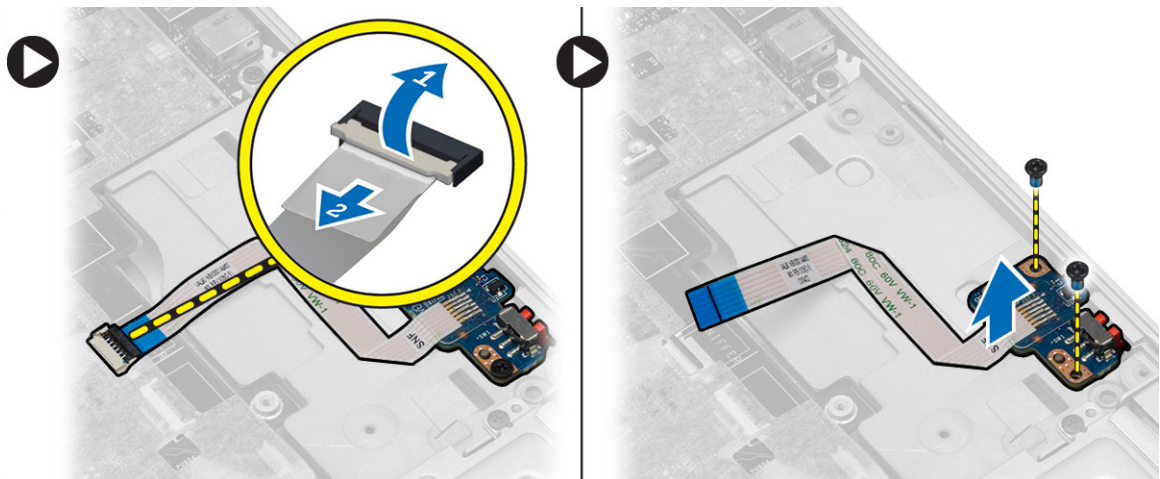

Installing the WiFi-Switch Board

1. Place the WiFi-switch board in its slot.
2. Tighten the screws to secure the WiFi-switch board to the computer.
3. Connect the WiFi-switch board cable to the system board.
4. Install:
 - a. palmrest assembly
 - b. base cover
 - c. base corner caps
 - d. display-hinge cap
 - e. optical drive
 - f. hard drive
 - g. keyboard
 - h. keyboard trim
 - i. battery
 - j. ExpressCard
 - k. SD Card
5. Follow the procedures in *After Working Inside Your Computer*.

Removing the System Board

1. Follow the procedures in *Before Working Inside Your Computer*.
2. Remove:
 - a. SD Card
 - b. ExpressCard
 - c. battery
 - d. keyboard trim
 - e. keyboard
 - f. hard drive
 - g. optical drive
 - h. display-hinge cover
 - i. base cover
 - j. base corner caps
 - k. power connector
 - l. coin-cell battery
 - m. memory
 - n. WLAN card
 - o. WWAN card
 - p. heatsink assembly
 - q. processor
 - r. palmrest assembly
 - s. ExpressCard cage

3. Disconnect the coin-cell battery and the speaker cables from the system board.

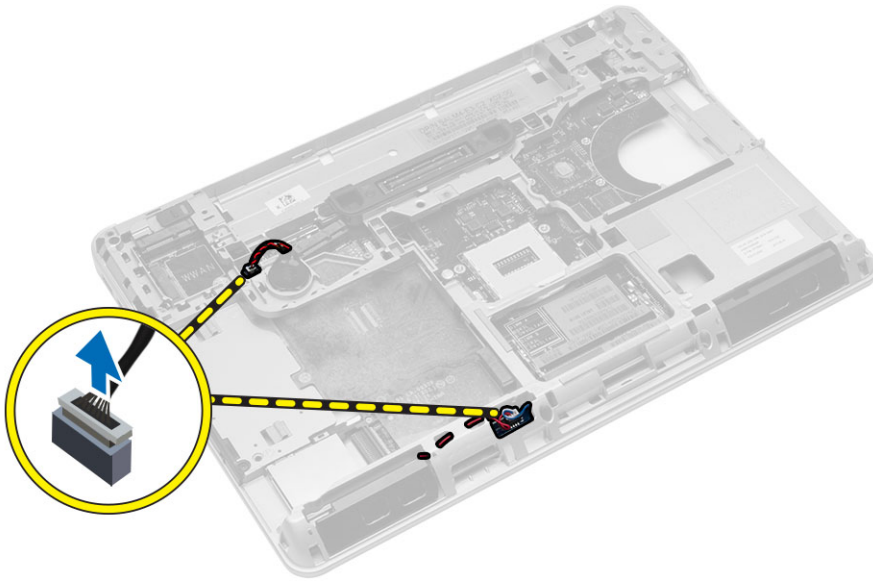

4. Remove the screws that secure the system board to the computer and perform the following steps as shown in the illustration:
 - a. Lift the latch that secures the WiFi-switch board cable to the system board [1].
 - b. Disconnect the WiFi-switch board cable from the system board [2].

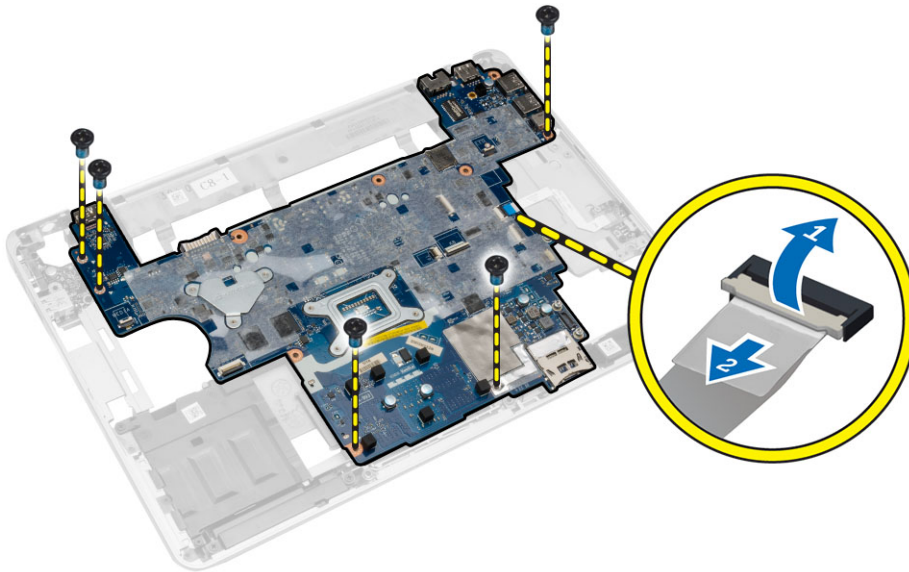

5. Lift the system board from the computer.

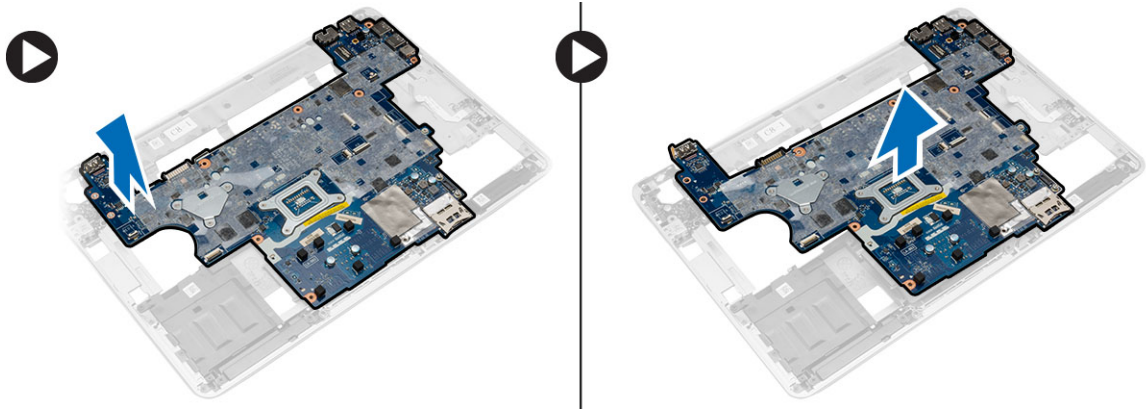

Installing the System Board

1. Place the system board to align with the ports on the computer.
2. Connect the WiFi-Switch board cable to the system board and tighten the screws to secure the system board.
3. Connect the following cables to the system board:
 - a. speaker
 - b. coin-cell battery
4. Install:
 - a. ExpressCard cage
 - b. palmrest assembly
 - c. processor
 - d. heatsink assembly
 - e. WWAN
 - f. WLAN card
 - g. memory
 - h. coin-cell battery
 - i. power connector
 - j. base corner caps
 - k. base cover
 - l. display-hinge cover
 - m. optical drive
 - n. hard drive
 - o. keyboard trim
 - p. keyboard
 - q. battery
 - r. ExpressCard
 - s. SD card
5. Follow the procedures in *After Working Inside Your Computer*.

Removing the Speakers

1. Follow the procedures in *Before Working Inside Your Computer*.
2. Remove:
 - a. SD card
 - b. ExpressCard
 - c. battery
 - d. keyboard trim
 - e. keyboard
 - f. hard drive
 - g. optical drive
 - h. display-hinge cover
 - i. base cover
 - j. base corner caps
 - k. palmrest assembly
 - l. power connector
 - m. coin-cell battery
 - n. memory
 - o. WLAN card
 - p. WWAN card
 - q. heatsink assembly
 - r. processor
 - s. ExpressCard cage
 - t. display assembly
 - u. system board
3. Remove the speaker cable from the routing channels. Remove the screws that secure the speakers to the computer and lift the speakers from the computer.

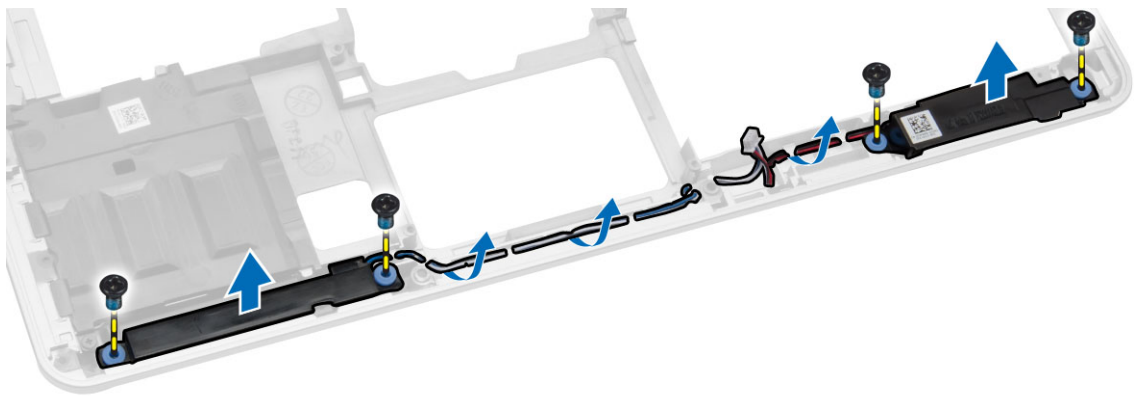

Installing the Speakers

1. Align the speakers in its position on the computer and route the speaker cable through the routing channels on the computer.
2. Tighten the screws to secure the speakers.

3. Install:
 - a. system board
 - b. display assembly
 - c. ExpressCard cage
 - d. processor
 - e. heatsink assembly
 - f. WWAN card
 - g. WLAN card
 - h. memory
 - i. coin-cell battery
 - j. power connector
 - k. palmrest assembly
 - l. base corner caps
 - m. base cover
 - n. display-hinge cover
 - o. optical drive
 - p. hard drive
 - q. keyboard
 - r. battery
 - s. ExpressCard
 - t. SD card
4. Follow the procedures in *After Working Inside Your Computer*.

Removing the I/O Board

1. Follow the procedures in *Before Working Inside Your Computer*.
2. Remove:
 - a. SD card
 - b. express card
 - c. battery
 - d. keyboard trim
 - e. keyboard
 - f. hard drive
 - g. optical drive
 - h. display-hinge cover
 - i. base cover
 - j. memory
 - k. WLAN card
 - l. WWAN card
 - m. base corner covers
 - n. palmrest
 - o. speaker
 - p. display assembly
 - q. system board

3. Disconnect the I/O cable from the system board and remove the screws that secure the I/O board to the computer. Remove the I/O board from the computer.

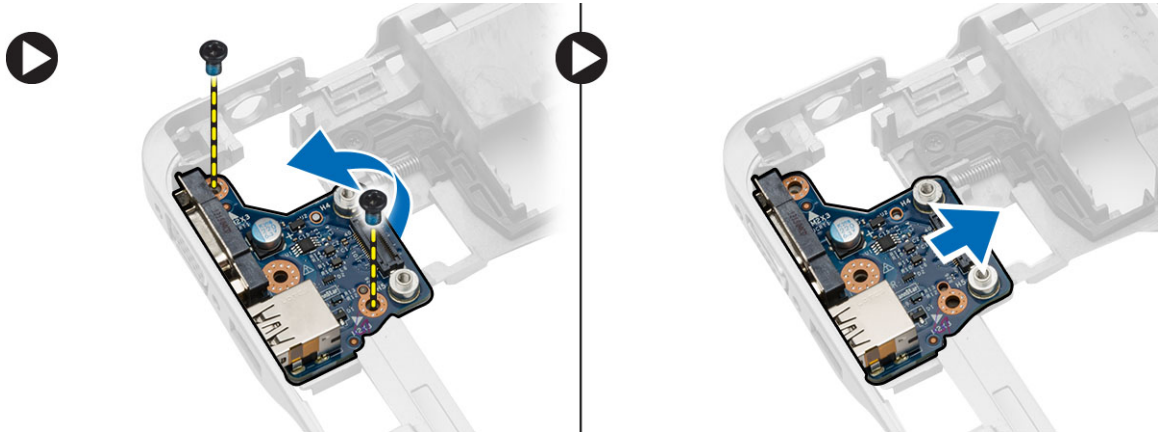

Installing the I/O Board

1. Place the I/O board in its slot and snap it in place.
2. Tighten the screws to secure the I/O board.
3. Connect the I/O cable to the system board.
4. Install:
 - a. system board
 - b. display assembly
 - c. speaker
 - d. palmrest
 - e. base corner covers
 - f. WWAN card
 - g. WLAN card
 - h. memory
 - i. base cover
 - j. display-hinge cover
 - k. optical drive
 - l. keyboard
 - m. keyboard trim
 - n. hard drive
 - o. battery
 - p. express cage
 - q. SD card
5. Follow the procedures in *After Working Inside Your Computer*.

Removing the Display Assembly

1. Follow the procedures in *Before Working Inside Your Computer*.
2. Remove:
 - a. battery
 - b. keyboard trim
 - c. keyboard
 - d. hard drive
 - e. optical drive
 - f. display-hinge cover
 - g. base cover
 - h. base corner caps
 - i. power connector
 - j. palmrest assembly
3. Remove the antenna cables connected to wireless solutions from the routing channels.

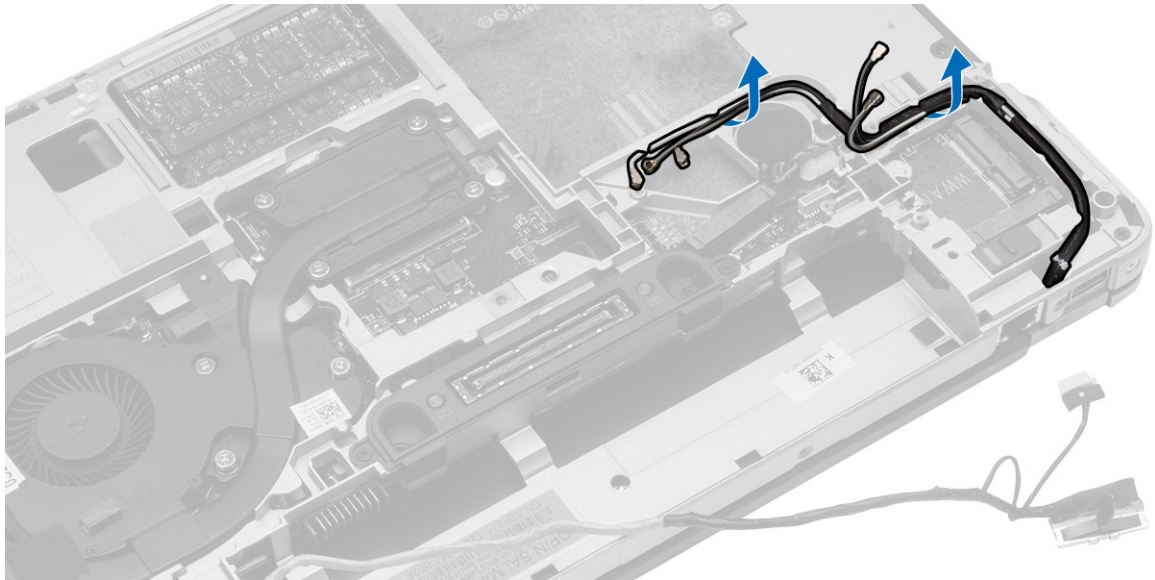

4. Remove the screws that secure the display assembly to the computer. Disconnect the LVDS cable and release the LVDS cable and camera cable from the routing channel.

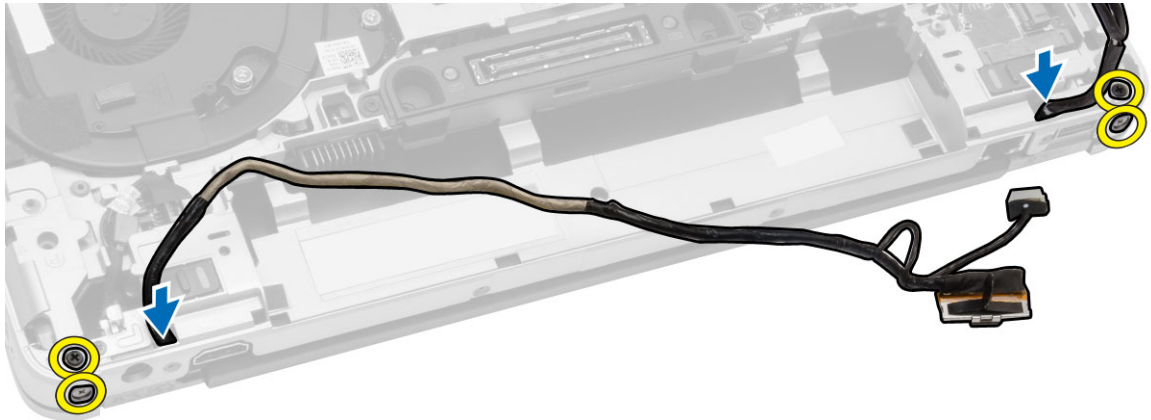

5. Remove the display assembly from the computer.



Installing the Display Assembly

1. Place the display assembly in its position on the computer.
2. Route the LVDS cable and the camera cable through the routing channel. Tighten the screws to secure the display assembly.
3. Connect wireless antennas along their channels and connect them back to their respective wireless modules.

4. Install:
 - a. palmrest assembly
 - b. power connector
 - c. base corner caps
 - d. base cover
 - e. display-hinge cover
 - f. optical drive
 - g. hard drive
 - h. keyboard
 - i. keyboard trim
 - j. battery
5. Follow the procedures in *After Working Inside Your Computer*.

Removing the Display Bezel

1. Follow the procedures in *Before Working Inside Your Computer*.
2. Remove:
 - a. battery
 - b. display-hinge cap
 - c. base cover
 - d. base corner caps
 - e. display assembly
3. Pry up along the edges to release the display bezel.

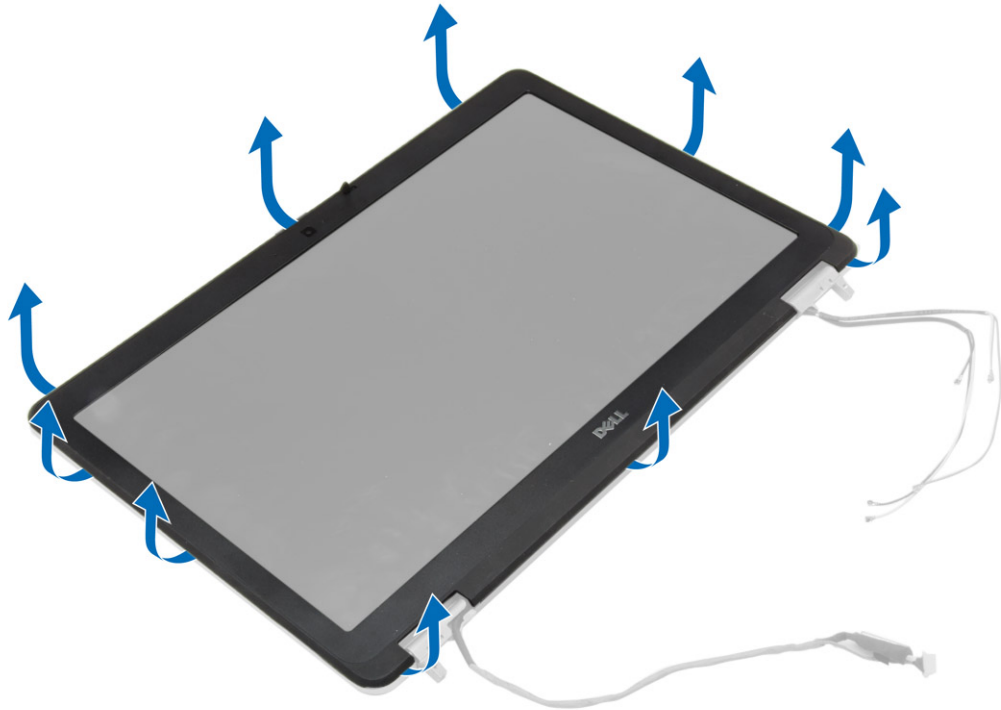

4. Remove the display bezel from the display assembly.



Installing the Display Bezel

1. Place the display bezel onto the display assembly.
2. Starting from the top corner, press on the display bezel and work around the entire bezel until it clicks onto the display assembly.
3. Press on the left and right edges of the display bezel.
4. Install:
 - a. display assembly
 - b. base corner caps
 - c. base cover
 - d. display-hinge cap
 - e. battery
5. Follow the procedures in *After Working Inside Your Computer*.

Removing the Display Panel

1. Follow the procedures in *Before Working Inside Your Computer*.
2. Remove:
 - a. battery
 - b. display-hinge cap
 - c. base cover
 - d. base corner caps
 - e. display assembly
 - f. display bezel
3. Remove the screws that secure the display panel to the display assembly.

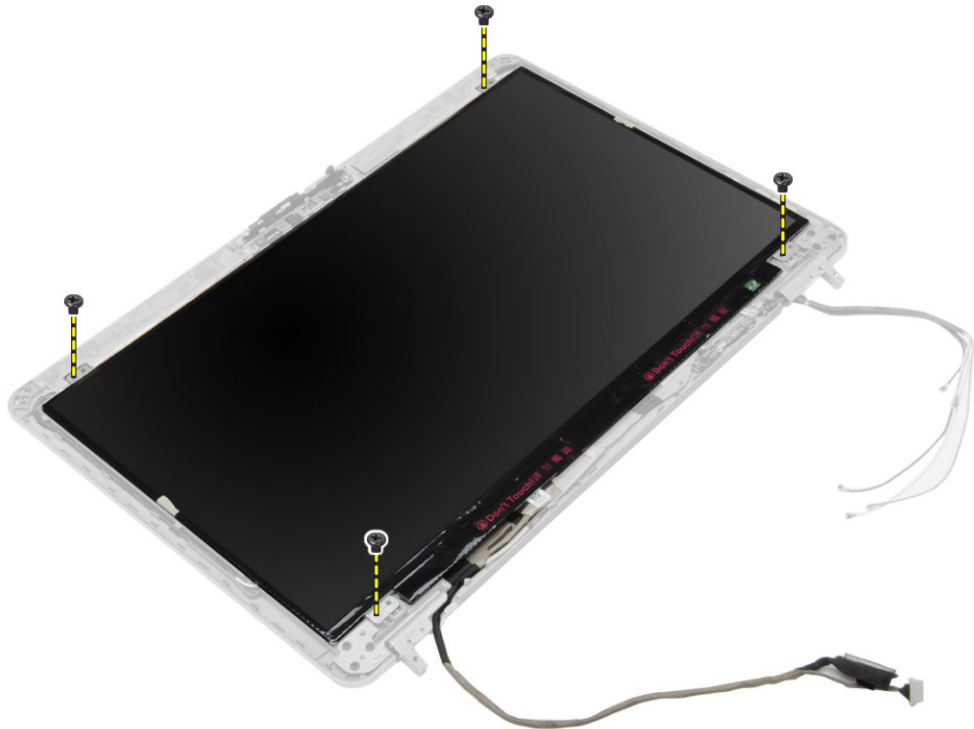

4. Flip the display panel over.

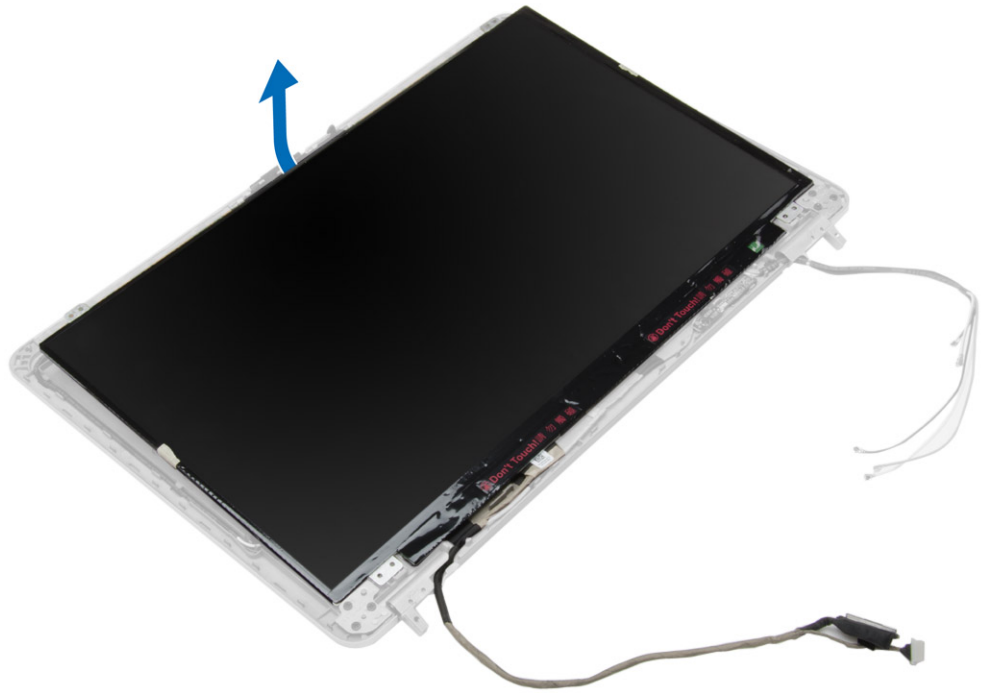

5. Peel off the LVDS cable-connector tape and disconnect the LVDS cable from the display panel. Remove the display panel from the display assembly.

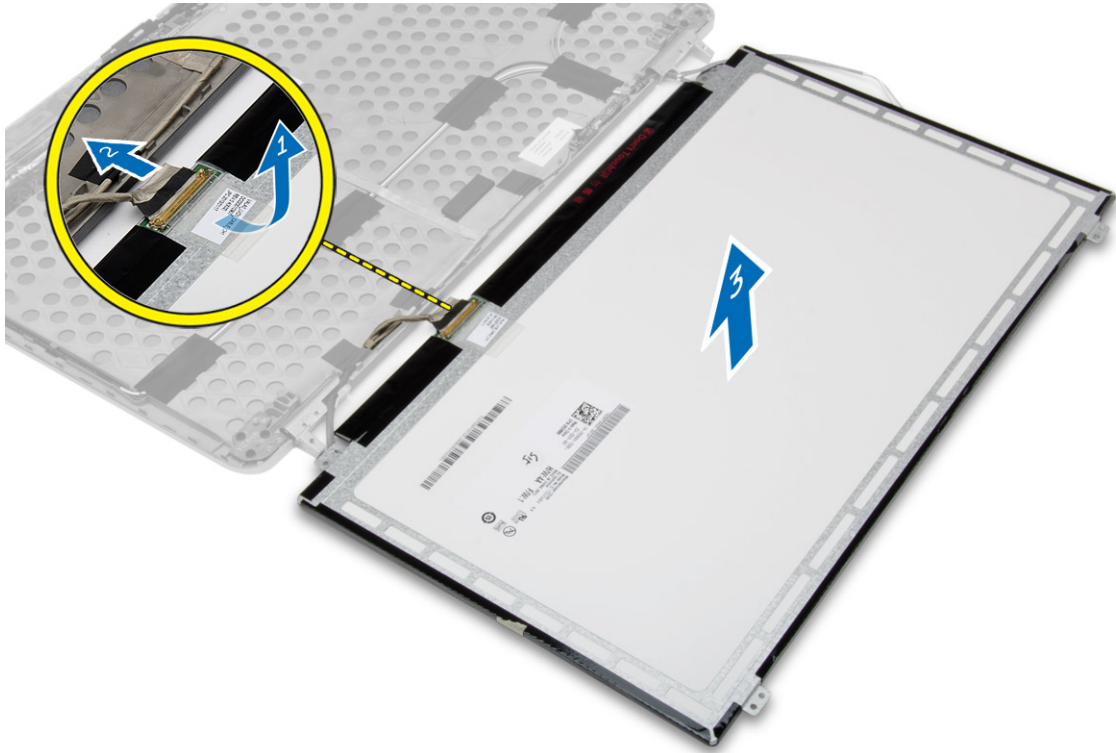

Installing the Display Panel

1. Connect the LVDS cable and stick the LVDS cable-connector tape.
2. Flip the display and place it in the display assembly.
3. Tighten the screws to secure the display panel to the display assembly.
4. Install:
 - a. display bezel
 - b. display assembly
 - c. base corner caps
 - d. base cover
 - e. display-hinge cap
 - f. battery
5. Follow the procedures in *After Working Inside Your Computer*.

Removing the Display Hinges

1. Follow the procedures in *Before Working Inside Your Computer*.
2. Remove:
 - a. battery
 - b. display-hinge cap
 - c. base cover
 - d. base corner caps
 - e. display assembly
 - f. display bezel
 - g. display panel
3. Perform the following steps as shown in the illustration:
 - a. Remove the screws that secure the display hinges to the display assembly.
 - b. Remove the display hinges from the computer.

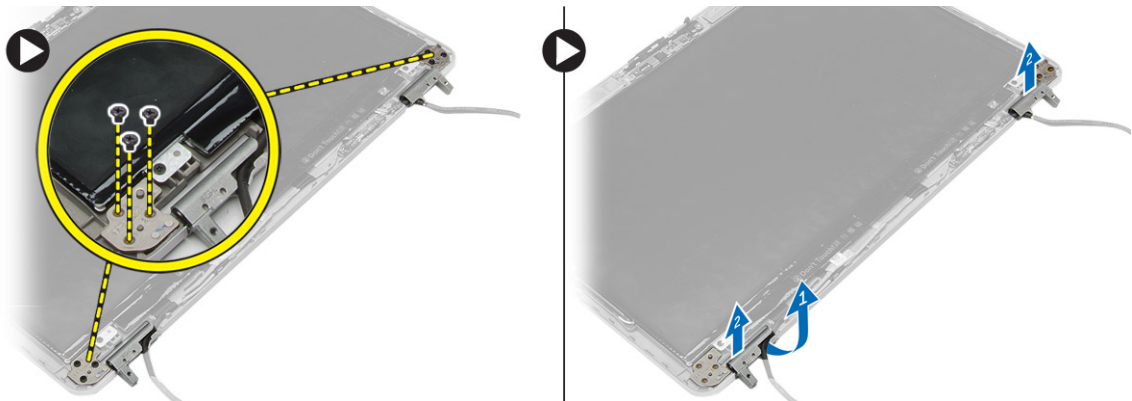

Installing the Display Hinges

1. Place the display hinges in its location on the computer.
2. Tighten the screws to secure the display hinges to the display assembly.
3. Install:
 - a. display panel
 - b. display bezel
 - c. display assembly
 - d. base corner caps
 - e. base cover
 - f. display-hinge cap
 - g. battery
4. Follow the procedures in *After Working Inside Your Computer*.

Removing the Camera

1. Follow the procedures in *Before Working Inside Your Computer*.
2. Remove:
 - a. battery
 - b. display assembly
 - c. display bezel
3. Perform the following steps as shown in the illustration:
 - a. Disconnect the camera cable.
 - b. Remove the screw that secures the camera module.
 - c. Lift the camera module from the computer.

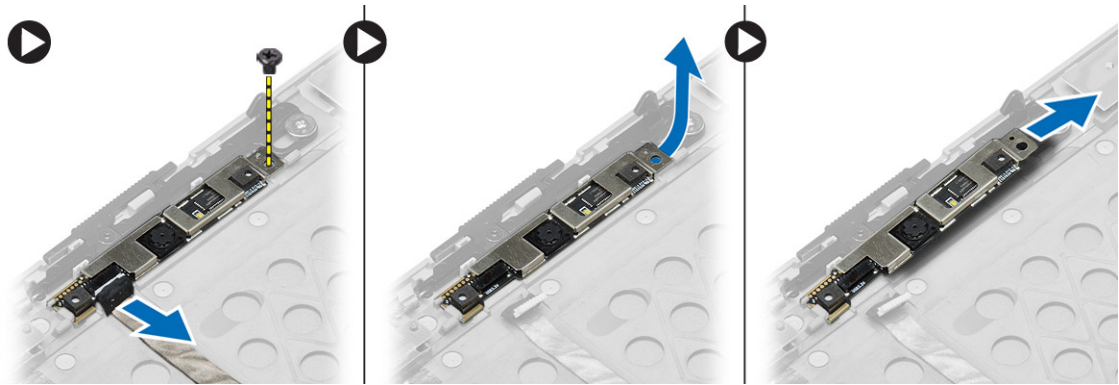

Installing the Camera

1. Place the camera module in its slot in the computer.
2. Tighten the screw to secure the camera to the display assembly.
3. Connect the camera cable.
4. Install:
 - a. display bezel
 - b. display assembly
 - c. battery
5. Follow the procedures in *After Working Inside Your Computer*.

System Setup

System Setup enables you to manage your computer hardware and specify BIOS-level options. From the System Setup, you can:

- Change the NVRAM settings after you add or remove hardware
- View the system hardware configuration
- Enable or disable integrated devices
- Set performance and power management thresholds
- Manage your computer security

Boot Sequence

Boot Sequence allows you to bypass the System Setup-defined boot device order and boot directly to a specific device (for example: optical drive or hard drive). During the Power-on Self Test (POST), when the Dell logo appears, you can:

- Access System Setup by pressing <F2> key
- Bring up the one-time boot menu by pressing <F12> key

The one-time boot menu displays the devices that you can boot from including the diagnostic option. The boot-menu options are:

- Removable Drive (if available)
- STXXXX Drive

 **NOTE:** XXX denotes the SATA drive number.

- Optical Drive
- Diagnostics

 **NOTE:** Choosing Diagnostics, will display the **ePSA diagnostics** screen.

The boot sequence screen also displays the option to access the System Setup screen.

Navigation Keys

The following table displays the system setup navigation keys.



 **NOTE:** For most of the system setup options, changes that you make are recorded but do not take effect until you restart the system.

Table 1. Navigation Keys

Keys	Navigation
Up arrow	Moves to the previous field.
Down arrow	Moves to the next field.

Keys	Navigation
<Enter>	Allows you to select a value in the selected field (if applicable) or follow the link in the field.
Spacebar	Expands or collapses a drop-down list, if applicable.
<Tab>	Moves to the next focus area.
	 NOTE: For the standard graphics browser only.
<Esc>	Moves to the previous page till you view the main screen. Pressing <Esc> in the main screen displays a message that prompts you to save any unsaved changes and restarts the system.
<F1>	Displays the System Setup help file.

System Setup Options



 **NOTE:** Depending on your computer and its installed devices, the items listed in this section may or may not appear.

Table 2. General

Option	Description
System Information	<p>This section lists the primary hardware features of your computer.</p> <ul style="list-style-type: none"> • System Information - Displays BIOS Version, Service Tag, Asset Tag, Ownership Tag, Ownership Date, Manufacture Date, and the Express Service Code. • Memory Information - Displays Memory Installed, Memory Available, Memory Speed, Memory Channel Mode, Memory Technology, DIMM A Size, DIMM B Size • Processor Information - Displays Processor Type, Core Count, Processor ID, Current Clock Speed, Minimum Clock Speed, Maximum Clock Speed, Processor L2 Cache, Processor L3 Cache, HT Capable, and 64-Bit Technology. • Device Information - Displays Primary Hard Drive, Modular Bay Device, LOM MAC Address, Audio Controller , Video Controller, and Wi-Fi Device.
Battery Information	Displays the charge status of the battery.
Boot Sequence	<p>Allows you to change the order in which the computer attempts to find an operating system. All the below options are selected.</p> <ul style="list-style-type: none"> • Diskette Drive • Internal HDD • Onboard NIC • USB Storage Device • CD/DVD/CD-RW Drive <p>You can also choose the Boot List option. The options are:</p>

Option	Description
	<ul style="list-style-type: none"> • Legacy (Default Setting) • UEFI
Advanced Boot Options	Enable Legacy Option ROMs (enable by default)
Date/Time	Allows you to set the date and time.

Table 3. System Configuration

Option	Description
Integrated NIC	<p>Allows you to configure the integrated network controller. The options are:</p> <ul style="list-style-type: none"> • Disabled • Enabled • Enabled w/PXE (Default Setting) • Enable UEFI Network Stack - If this option is enabled, UEFI networking protocols are installed/available, allowing pre-OS and early OS networking features to use any enabled NICs. This may be used without PXE turned on.
Parallel Port	<p>Allows you to define and set how the parallel port on the docking station operates. You can set the parallel port to:</p> <ul style="list-style-type: none"> • Disabled • AT (Default Setting) • PS2 • ECP
Serial Port	<p>Identifies and defines the serial port settings. You can set the serial port to:</p> <ul style="list-style-type: none"> • Disabled • COM1 (Default Setting) • COM2 • COM3 • COM4 <p> NOTE: The operating system may allocate resources even if the setting is disabled.</p>
SATA Operation	<p>Allows you to configure the internal SATA hard-drive controller. The options are:</p> <ul style="list-style-type: none"> • Disabled • ATA • AHCI • RAID On (Default Setting)





Option	Description
Drives	<p> NOTE: SATA is configured to support RAID mode.</p> <p>Allows you to configure the SATA drives on board. The options are:</p> <ul style="list-style-type: none"> • SATA-0 • SATA-1 • SATA-2 • SATA-4
SMART Reporting	<p>Default Setting: All drives are enabled.</p> <p>This field controls if the hard drive errors for the integrated drives are reported during system startup. This technology is part of the SMART (Self Monitoring Analysis and Reporting Technology) specification. This option is disabled by default.</p> <ul style="list-style-type: none"> • Enable SMART Reporting
USB Configuration	<p>Allows you to define the USB configuration. The options are:</p> <ul style="list-style-type: none"> • Enable Boot Support • Enable External USB Port • Enable USB 3.0 Controller
USB PowerShare	<p>Default Setting: All the options are enabled.</p> <p>Allows you to configure the behavior of the USB PowerShare feature. The option is disabled by default.</p> <ul style="list-style-type: none"> • Enable USB PowerShare
Audio	<p>Allows you to enable or disable the intergrated audio controller.</p> <ul style="list-style-type: none"> • Enable Audio (enable by default)
Keyboard Illumination	<p>Allows you to choose the operating mode of the keyboard illumination feature. The options are:</p> <ul style="list-style-type: none"> • Disabled (Default Setting) • Level is 25% • Level is 50% • Level is 75% • Level is 100%
Unobtrusive Mode	<p>Allows you to set the mode that will turn off all light and sound emissions from the system. The option is disabled by default.</p>

Option	Description
Miscellaneous Devices	<p>Allows you enable or disable the various on board devices. The options are:</p> <ul style="list-style-type: none"> • Enable Internal Modem • Enable Microphone • Enable Camera • Enable Module Bay • Enable ExpressCard • Enable Hard Drive Free Fall Protection <p>Default Setting: All devices are enabled You can select if you want to enable or disable media card. The options are:</p> <ul style="list-style-type: none"> • Enable Media Card (Default Setting) • Disable Media Card

Table 4. Video

Option	Description
LCD Brightness	Allows you to set the panel brightness when the ambient sensor is Off.

Table 5. Security

Option	Description
Admin Password	<p>Allows you to set, change, or delete the administrator (admin) password.</p> <p> NOTE: You must set the admin password before you set the system or hard drive password.</p> <p> NOTE: Successful password changes take effect immediately.</p> <p> NOTE: Deleting the admin password automatically deletes the system password and the hard drive password.</p> <p> NOTE: Successful password changes take effect immediately.</p> <p>Default Setting: Not set</p>
System Password	<p>Allows you to set, change or delete the system password.</p> <p> NOTE: Successful password changes take effect immediately.</p> <p>Default Setting: Not set</p>
Internal HDD-0 Password	<p>This field lets you set, change, or delete the administrator (admin) password (sometimes called the setup password). The admin password enables several security features.</p> <p>The drive does not have a password set by default.</p> <ul style="list-style-type: none"> • Enter the old password • Enter the new password • Confirm the new password
Strong Password	Allows you to enforce the option to always set strong passwords.

Option	Description
	Default Setting: Enable Strong Password is not selected.
Password Configuration	You can define the length of your password. Min = 4 , Max = 32
Password Bypass	Allows you to enable or disable the permission to bypass the System and the Internal HDD password, when they are set. The options are: <ul style="list-style-type: none"> • Disabled (Default Setting) • Reboot bypass
Password Change	Allows you to enable the disable permission to the System and Hard Drive passwords when the admin password is set. Allow Non-Admin Password Changes (Default Setting)
Non-Admin Setup Changes	Allows you to determine whether changes to setup option are permitted when an administrator password is set. The option is disabled by default.
TPM Security	Allows you to enable the Trusted Platform Module (TPM) during POST. The option is disabled by default.
Computrace	Allows you to activate or disable the optional Computrace software The options are: <ul style="list-style-type: none"> • Deactivate (Default Setting) • Disable • Activate <p> NOTE: The Activate and Disable options will permanently activate or disable the feature and no further changes will be allowed</p>
CPU XD Support	Allows you to enable the Execute Disable mode of the processor. Enable CPU XD Support (Default Setting)
OROM Keyboard Access	Allows you to set access to enter the Option ROM Configuration screens using hotkeys during boot process. The options are: <ul style="list-style-type: none"> • Enable (Default Setting) • One Time Enable • Disable
Admin Setup Lockout	Allows you to enable or disable the option to enter setup when an admin password is set. <ul style="list-style-type: none"> • Enable Admin Setup Lockout - This option is not set by default.

Table 6. Secure Boot

Option	Description
Secure Boot Enable	Allows you to enable or disable the secure boot feature. The options are: <ul style="list-style-type: none"> • Disabled (Default Setting) • Enabled



Option	Description
	 NOTE: For enable system need to be UEFI boot mode and enable legacy option ROMs to be turned off.
Expert key Management	<p>Allows you to manipulate the security key databases only if the system is in Custom Mode. The Enable Custom Mode option is disabled by default. The options are:</p> <ul style="list-style-type: none"> • PK • KEK • db • dbx <p>If you enable the Custom Mode, the relevant options for PK, KEK, db, and dbx appear. The options are:</p> <ul style="list-style-type: none"> • Save to File- Saves the key to a user-selected file • Replace from File- Replaces the current key with a key from a user-selected file • Append from File- Adds a key to the current database from a user-selected file • Delete- Deletes the selected key • Reset All Keys- Resets to default setting • Delete All Keys- Deletes all the keys <p> NOTE: If you disable the Custom Mode, all the changes made will be erased and the keys will restore to default settings.</p>

Table 7. Performance

Option	Description
Multi Core Support	<p>This field specifies whether the process will have one or all cores enabled. The performance of some applications will improve with the additional cores. This option is enabled by default. Allows you to enable or disable multi-core support for the processor. The options are:</p> <ul style="list-style-type: none"> • All (Default Setting) • 1 • 2
Intel SpeedStep	<p>Allows you to enable or disable the Intel SpeedStep feature. Default Setting: Enable Intel SpeedStep</p>
C States Control	<p>Allows you to enable or disable the additional processor sleep states. The option is enabled by default.</p>
Limit CPUID	<p>Allows you to limit the maximum value the processor standard CPUID function will support. The option is disabled by default.</p>
Intel TurboBoost	<p>Allows you to enable or disable the Intel TurboBoost mode of the processor.</p>

Option	Description
Hyper-Thread Control	Default Setting: Enable Intel TurboBoost Allows you to enable or disable the HyperThreading in the processor. Default Setting: Enabled
Rapid Start Technology	Allows you to set the rapid start time. The option is set by default.

Table 8. Power Management

Option	Description
AC Behavior	Allows the computer to power-uon automatically, when AC adapter is plugged. The option is disabled. <ul style="list-style-type: none"> Wake on AC
Auto On Time	Allows you to set the time at which the computer must turn on automatically. The options are: <ul style="list-style-type: none"> Disabled (Default Setting) Every Day Weekdays Select Days - The system will power up on days selected above at the time you specified. <p> NOTE: This feature does not work if you turn off your computer using the switch on a power strip or surge protector or if Auto Power is set to disabled.</p>
USB Wake Support	Allows you to enable the USB devices to wake the computer from standby mode. The option is disabled <ul style="list-style-type: none"> Enable USB Wake Support
Wireless Radio Control	Allows you to control the WLAN and WWAN radio. The options are: <ul style="list-style-type: none"> Control WLAN radio Control WWAN radio <p>Default Setting: Both the options are disabled.</p>
Wake on LAN/WLAN	This option allows the computer to power up from the off state when triggered by a special LAN signal. Wake-up from the Standby state is unaffected by this setting and must be enabled in the operating system. This feature only works when the computer is connected to AC power supply. <ul style="list-style-type: none"> Disabled - Does not allow the system to power on by special LAN signals when it receives a wake-up signal from the LAN or wireless LAN. (Default Setting) LAN Only - Allows the system to be powered on by special LAN signals. WLAN Only LAN or WLAN LAN with PXE Boot
Block Sleep	Allows you to block the computer from entering into the sleep state. Option is disabled by default.

Option	Description
	<ul style="list-style-type: none"> Block Sleep (S3)
Peak Shift	Allows you to set the peak shift. The option is disabled by default.
Advanced Battery Charge Configuration	Allows you to enable the advance battery charge mode. The option is disabled by default.
Primary Battery Charge Configuration	A Long Life Cycle battery is currently attached. The charge configuration cannot be changed with this type of battery.
Battery Slice Charge Configuration	Allows you to define the how to charge the battery. The options are: <ul style="list-style-type: none"> Standard Charge Express Charge (Default Setting)
Intel(R) Smart Connect Technology	Allows you to enable the system to sense nearby wireless connection while the system is asleep. The option is disabled by default.

Table 9. POST Behavior

Option	Description
Adapter Warnings	Allows you to activate the adapter warning messages when certain power adapters are used. The option is enabled by default. <ul style="list-style-type: none"> Enable Adapter Warnings
Keypad (Embedded)	Allows you to choose one of the methods to enable the keypad that is embedded in the internal keyboard. The options are: <ul style="list-style-type: none"> Fn Key Only (Default Setting) By Numlock
Mouse/Touchpad	Allows you to define how the computer handles the mouse and touchpad input. The options are: <ul style="list-style-type: none"> Serial Mouse PS2 Mouse Touchpad/PS-2 Mouse (Default Setting)
Numlock Enable	Specifies if the NumLock function can be enabled when the computer boots. This option is enabled by default. <ul style="list-style-type: none"> Enable Numlock
Fn Key Emulation	Allows you to match the <Scroll Lock> key feature of PS-2 keyboard with the <Fn> key feature in an internal keyboard. The option is enabled by default. <ul style="list-style-type: none"> Enable Fn Key Emulation
Fastboot	Allows you to speed up the boot processes. The options are: <ul style="list-style-type: none"> Minimal Thorough (Default Setting) Auto

Option	Description
Extend BIOS POST Time	Allows you to create an additional pre-boot delay. The options are: <ul style="list-style-type: none"> • 0 seconds (Default Setting) • 5 seconds • 10 seconds
MEBx Hotkey	Allows you to enable the MEBx hotkey function if required. The options is enabled by default.

Table 10. Virtualization Support

Option	Description
Virtualization	This option specifies whether a Virtual Machine Monitor (VMM) can utilize the additional hardware capabilities provided by Intel Virtualization technology. <ul style="list-style-type: none"> • Enable Intel Virtualization Technology - Default Setting.

Table 11. Wireless

Option	Description
Wireless Switch	Allows you to determine which wireless device can be controlled by the wireless switch. The options are: <ul style="list-style-type: none"> • WWAN • WiGig • WLAN • Bluetooth <p>All options are enabled by default.</p>
Wireless Device Enable	Allows you to enable or disable the wireless devices. The options are: <ul style="list-style-type: none"> • WWAN • Bluetooth • WLAN/WiGig <p>All options are enabled by default.</p>

Table 12. Maintenance



Option	Description
Service Tag	Displays the service tag of your computer.
Asset Tag	Allows you to create a system asset tag if an asset tag is not already set. This option is not set by default.

Table 13. System Logs

Option	Description
BIOS events	Displays the system event log and allows you to clear the log.
Thermal Events	Displays the thermal events and allows you to clear the log.
Power Events	Displays the power events and allows you to clear the log.

Updating the BIOS

It is recommended to update your BIOS (system setup), on replacing the system board or if an update is available. For laptops, ensure that your computer battery is fully charged and connected to a power outlet

1. Restart the computer.
2. Go to **dell.com/support**.
3. If you have your computer's Service Tag or Express Service Code:
 -  **NOTE:** To locate the Service Tag, click **Where is my Service Tag?**
 -  **NOTE:** If you cannot find your Service Tag, click **Detect Service Tag**. Proceed with the instructions on screen.
4. Enter the **Service Tag** or **Express Service Code** and click **Submit**.
5. If you are unable to locate or find the Service Tag, click the Product Category of your computer.
6. Choose the **Product Type** from the list.
7. Select your computer model and the **Product Support** page of your computer appears.
8. Click **Drivers & Downloads**.
9. On the Drivers and Downloads screen, under the **Operating System** drop-down list, select **BIOS**.
10. Identify the latest BIOS file and click **Download File**.
11. Select your preferred download method in the **Please select your download method below window**; click **Download File**.
The **File Download** window appears.
12. Click **Save** to save the file on your computer.
13. Click **Run** to install the updated BIOS settings on your computer.
Follow the instructions on the screen.

System and Setup Password

You can create a system password and a setup password to secure your computer.

Password Type	Description
System password	Password that you must enter to log on to your system.
Setup password	Password that you must enter to access and make changes to the BIOS settings of your computer.

 **CAUTION:** The password features provide a basic level of security for the data on your computer.

 **CAUTION:** Anyone can access the data stored on your computer if is not locked and left unattended.

 **NOTE:** Your computer is shipped with the system and setup password feature disabled.

Assigning a System Password and Setup Password

You can assign a new **System Password** and/or **Setup Password** or change an existing **System Password** and/or **Setup Password** only when **Password Status** is **Unlocked**. If the Password Status is **Locked**, you cannot change the System Password.



NOTE: If the password jumper is disabled, the existing System Password and Setup Password is deleted and you need not provide the system password to log on to the computer.

To enter a system setup, press <F2> immediately after a power-on or reboot.

1. In the **System BIOS** or **System Setup** screen, select **System Security** and press <Enter>. The **System Security** screen appears.
2. In the **System Security** screen, verify that **Password Status** is **Unlocked**.
3. Select **System Password**, enter your system password, and press <Enter> or <Tab>. Use the following guidelines to assign the system password:
 - A password can have up to 32 characters.
 - The password can contain the numbers 0 through 9.
 - Only lower case letters are valid, upper case letters are not allowed.
 - Only the following special characters are allowed: space, ("), (+), (,), (-), (.), (/), (:), ([, (\), (]), (').Re-enter the system password when prompted.
4. Type the system password that you entered earlier and click **OK**.
5. Select **Setup Password**, type your system password and press <Enter> or <Tab>. A message prompts you to re-type the setup password.
6. Type the setup password that you entered earlier and click **OK**.
7. Press <Esc> and a message prompts you to save the changes.
8. Press <Y> to save the changes. The computer reboots.

Deleting or Changing an Existing System and/or Setup Password

Ensure that the **Password Status** is **Unlocked** (in the System Setup) before attempting to delete or change the existing System and/or Setup password. You cannot delete or change an existing System or Setup password, if the **Password Status** is **Locked**.

To enter the System Setup, press <F2> immediately after a power-on or reboot.

1. In the **System BIOS** or **System Setup** screen, select **System Security** and press <Enter>. The **System Security** screen is displayed.
2. In the **System Security** screen, verify that **Password Status** is **Unlocked**.
3. Select **System Password**, alter or delete the existing system password and press <Enter> or <Tab>.
4. Select **Setup Password**, alter or delete the existing setup password and press <Enter> or <Tab>.
 -  **NOTE:** If you change the System and/or Setup password, re-enter the new password when prompted. If you delete the System and/or Setup password, confirm the deletion when prompted.
5. Press <Esc> and a message prompts you to save the changes.
6. Press <Y> to save the changes and exit from the System Setup. The computer reboots.

Diagnostics

If you experience a problem with your computer, run the ePSA diagnostics before contacting Dell for technical assistance. The purpose of running diagnostics is to test your computer's hardware without requiring additional equipment or risking data loss. If you are unable to fix the problem yourself, service and support personnel can use the diagnostics results to help you solve the problem.

Enhanced Pre-Boot System Assessment (ePSA) Diagnostics

The ePSA diagnostics (also known as system diagnostics) performs a complete check of your hardware. The ePSA is embedded with the BIOS and is launched by the BIOS internally. The embedded system diagnostics provides a set of options for particular devices or device groups allowing you to:

- Run tests automatically or in an interactive mode
- Repeat tests
- Display or save test results
- Run thorough tests to introduce additional test options to provide extra information about the failed device(s)
- View status messages that inform you if tests are completed successfully
- View error messages that inform you of problems encountered during testing



 **CAUTION:** Use the system diagnostics to test only your computer. Using this program with other computers may cause invalid results or error messages.

 **NOTE:** Some tests for specific devices require user interaction. Always ensure that you are present at the computer terminal when the diagnostic tests are performed.

1. Power-on the computer.
2. As the computer boots, press the <F12> key as the Dell logo appears.
3. On the boot menu screen, select the **Diagnostics** option.
The **Enhanced Pre-boot System Assessment** window is displayed, listing all devices detected in the computer. The diagnostics starts running the tests on all the detected devices.
4. If you wish to run a diagnostic test on a specific device, press <Esc> and click **Yes** to stop the diagnostic test.
5. Select the device from the left pane and click **Run Tests**.
6. If there are any issues, error codes are displayed.
Note the error code and contact Dell.

Device Status Lights

Table 14. Device Status Lights

- | | |
|---|--|
|  | Turns on when you turn on the computer and blinks when the computer is in a power management mode. |
|  | Turns on when the computer reads or writes data. |



Turns on steadily or blinks to indicate battery charge status.



Turns on when wireless networking is enabled.

The device status LEDs are usually located either on the top or left side of the keyboard. They are used to display the storage, battery and wireless devices connectivity and activity. Apart from that they can be useful as a diagnostic tool when there's a possible failure to the system.

The following table lists how to read the LED codes when possible errors occur.

Table 15. LED Lights

Storage LED	Power LED	Wireless LED	Fault Description
Blinking	Solid	Solid	A possible processor failure has occurred.
Solid	Blinking	Solid	The memory modules are detected but has encountered an error.
Blinking	Blinking	Blinking	A system board failure has occurred.
Blinking	Blinking	Solid	A possible graphics card/video failure has occurred.
Blinking	Blinking	Off	System failed on hard drive initialization OR System failed in Option ROM initialization.
Blinking	Off	Blinking	The USB controller encountered a problem during initialization.
Solid	Blinking	Blinking	No memory modules are installed/detected.
Blinking	Solid	Blinking	The display encountered a problem during initialization.
Off	Blinking	Blinking	The modem is preventing the system from completing POST
Off	Blinking	Off	Memory failed to initialize or memory is unsupported.

Battery Status Lights

If the computer is connected to an electrical outlet, the battery light operates as follows:

**Alternately
blinking amber
light and white
light**

An unauthenticated or unsupported non-Dell AC adapter is attached to your laptop.

**Alternately
blinking amber
light with steady
white light**

Temporary battery failure with AC adapter present.

**Constantly
blinking amber
light**

Fatal battery failure with AC adapter present.

Light off

Battery in full charge mode with AC adapter present.

White light on

Battery in charge mode with AC adapter present.

Technical Specifications

 **NOTE:** Offerings may vary by region. For more information regarding the configuration of your computer, click Start (Start icon) → **Help and Support**, and then select the option to view information about your computer.

 **NOTE:** In Windows 8, navigate to **Help and Support** to view information about your computer.

Table 16. System Information

Feature	Specification
Chipset	Mobile Intel QM87 Express chipset
DRAM bus width	64-bit
Flash EPROM	SPI 32 Mbits, 64 Mbits
PCIe bus	100 MHz
External Bus Frequency	PCIe Gen2 (5GT/s)

Table 17. Processor

Feature	Specification
Types	Intel Core i5 / i7 series
L3 cache	3 MB and 4MB

Table 18. Memory

Feature	Specification
Memory connector	Two SODIMM slots
Memory capacity	1 GB, 2 GB, 4 GB, or 8 GB
Memory type	DDR3L SDRAM (1600 MHz)
Minimum memory	2 GB
Maximum memory	16 GB

Table 19. Audio

Feature	Specification
Type	four-channel high-definition audio
Controller	Realtek ALC3226
Stereo conversion	24-bit (analog-to-digital and digital-to-analog)
Interface:	

Feature	Specification
Internal	high-definition audio
External	microphone-in, stereo headphones, external speakers connector
Speakers	two
Internal speaker amplifier	1 W (RMS) per channel
Volume controls	hot keys

Table 20. Video

Feature	Specification
Type	integrated on system board
Controller:	
UMA	Intel HD Graphics 4600
Discrete	AMD Radeon HD 8690M Graphics
Data bus	PCI-E Gen3 x8
External display support	<ul style="list-style-type: none"> • one VGA • one HDMI
	 NOTE: Support two DP/DVI ports through Docking station.

Table 21. Camera

Features	Specification
Camera Resolution	1280 x 720 pixels
Video Resolution (maximum)	1280 x 720 pixels
Diagonal viewing angle	74 °

Table 22. Communications

Features	Specification
Network adapter	10/100/1000 Mb/s Ethernet (RJ-45)
Wireless	internal wireless local area network (WLAN) and wireless wide area network (WWAN)

Table 23. Ports and Connectors

Features	Specification
Audio	one microphone/stereo headphone/speakers connector
Video	one 15-pin VGA connector and 19-pin HDMI connector
Network adapter	one RJ-45 connector
USB	Four USB 3.0-compliant connectors

Features	Specification
Memory card reader	Support upto SD4.0
Micro Subscriber Identity Module (uSIM) card	one
Docking port	one

Table 24. Contactless Smart Card

Feature	Specification
Supported Smart Cards/Technologies	BTO with USH

Table 25. Display

Feature	Specification
Type	HD Anti-Glare
Dimensions:	
Height	224.30 mm (8.83 inches)
Width	360.00 mm (14.17 inches)
Diagonal	396.24 mm (15.60 inches)
Active area (X/Y)	384 mm X 258 mm (15.12 inches X 10.16 inches)
Maximum resolution	1920 X 1080
Maximum Brightness	300 nits
Refresh rate	60 Hz
Minimum Viewing Angles:	
Horizontal	+/- 60°
Vertical	+/- 50°
Pixel pitch	0.179

Table 26. Keyboard

Feature	Specification
Number of keys	United States: 83 keys, United Kingdom: 84 keys, Brazil: 85 keys, and Japan: 87 keys

Table 27. Touchpad

Feature	Specification
Active Area:	
X-axis	80.00 mm
Y-axis	45.00 mm

Table 28. Battery

Feature	Specification	
Type	6 cell (65 WHr) lithium ion	9 cell (97 WHr) lithium ion
Dimensions:		
Depth	48.08 mm (1.89 inches)	71.79 mm (2.83 inches)
Height	20.00 mm (0.79 inch)	20.00 mm (0.79 inch)
Width	208.00 mm (8.19 inches)	214.00 mm (8.43 inches)
Weight	345.00 g (0.76 lb)	524.00 g (1.16 lb)
Voltage	11.1 VDC	
Temperature range:		
Operating	0 °C to 50 °C (32 °F to 158 °F)	
Non-Operating	-20 °C to 65 °C (4 °F to 149 °F)	
Coin-cell battery	3 V CR2032 lithium coin cell	

Table 29. AC Adapter

Feature	Specification
Type	65 W and 90 W
Input voltage	100 VAC to 240 VAC
Input current (maximum)	1.5 A
Input frequency	50 Hz to 60 Hz
Output current	3.34 A and 4.62 A
Rated output voltage	19.5 +/- 1.0 VDC
Temperature range:	
Operating	0 °C to 40 °C (32 °F to 104 °F)
Non-Operating	-40 °C to 70 °C (-40 °F to 158 °F)

Table 30. Physical

Feature	Specification
Height	<ul style="list-style-type: none"> • Front – 28.60 mm (1.12 inches) • Back – 30.80 mm (1.21 inches)
Width	338.00 mm (13.30 inches)
Depth	232.60 mm (9.16 inches)
Weight	2.12 kg (4.68 lb)

Table 31. Environmental

Feature	Specification
Temperature:	
Operating	0 °C to 35 °C (32 °F to 95 °F)
Storage	-40 °C to 65 °C (-40 °F to 149 °F)
Relative humidity (maximum):	
Operating	10 % to 90 % (non condensing)
Storage	5 % to 95 % (non condensing)
Altitude (maximum):	
Operating	-15.2 m to 3048 m (-50 to 10,000 ft) 0° to 35°C
Non-Operating	-15.24 m to 10,668 m (-50 ft to 35,000 ft)
Airborne contaminant level	G1 as defined by ISA-71.04-1985

Contacting Dell

 **NOTE:** If you do not have an active Internet connection, you can find contact information on your purchase invoice, packing slip, bill, or Dell product catalog.

Dell provides several online and telephone-based support and service options. Availability varies by country and product, and some services may not be available in your area. To contact Dell for sales, technical support, or customer service issues:

1. Visit dell.com/support
2. Select your support category.
3. Verify your country or region in the Choose a Country/Region drop-down menu at the top of page.
4. Select the appropriate service or support link based on your need.